



Miniature Types For Printed Circuits / Ser.PNZ / 10 mm

Technical data

Rated dissipation at $\vartheta_{amb}= 40^{\circ}\text{C}$	lin 0.15W / log 0.10W
Resistance value range	lin 100 Ω to 10 M Ω / log 1k Ω to 2 M Ω
Maximum voltage	lin 200 V dc / log 150 V dc
Electric angle of rotation	240 $^{\circ}\pm 20^{\circ}$
Mechanical angle of rotation	295 $^{\circ}\pm 5^{\circ}$
Operating torque	4 to 20 mNm
End stop torque	≥ 50 mNm
Weight PNZ10Z, PNZ11Z	0.72 g

PNZ10Z

"snap-in" version

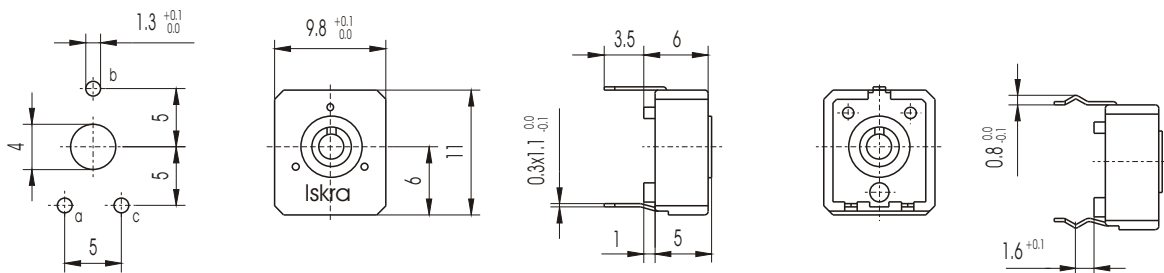

PNZ11Z

"snap-in" version

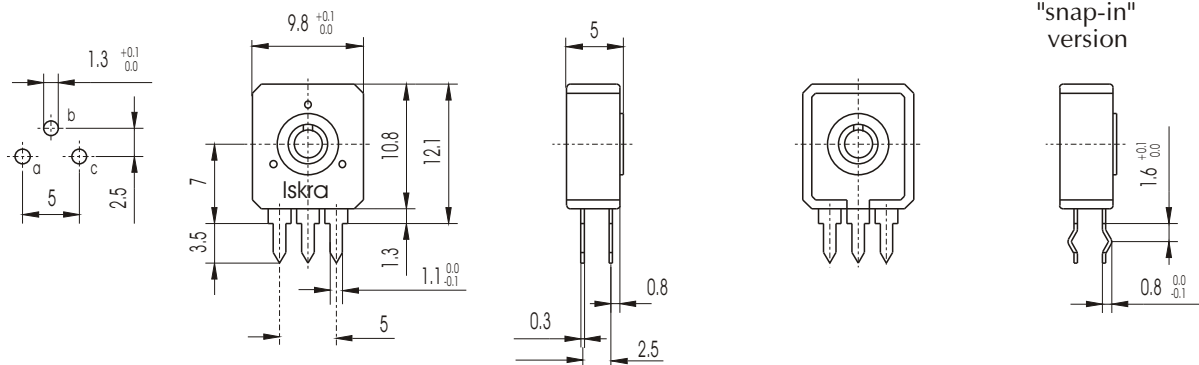

Accessories / Ser. PNZ - PNCZ / 10mm

ADJUSTMENT SLOT

PNZ10Z, PNZ11Z, PNCZ10Z, PNCZ11Z potentiometers adjustment slots shown in middle pot position

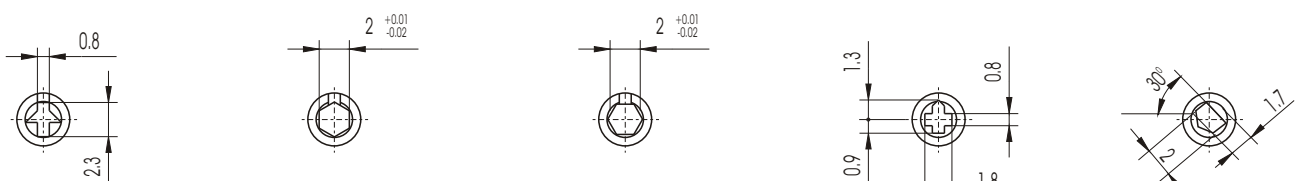

PNZ...

PNZ...A

PNZ...AU

PNZ...B

PNZ...C



THUMBWHEEL

PNZ10ZA, PNZ11ZA, PNCZ10ZA, PNCZ11ZA potentiometers thumbwheel

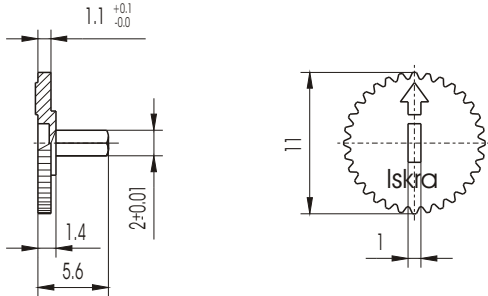

Thumbwheel Colour	Code
White	88 131 162
Black	88 131 393
Red	88 131 406
Blue	88 131 751
Green	88 131 560

PNZ10ZA, PNZ11ZA, PNCZ10ZA potentiometers shaft (STYLE1)

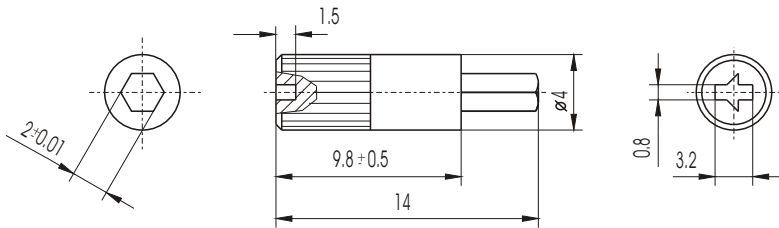

Shafts Colour	Code
White	88 131 161
Black	88 131 387
Red	88 131 490
Blue	88 131 598

PNZ10ZA, PNZ11ZA, PNCZ10ZA, PNCZ11ZA potentiometers shaft (STYLE 2)

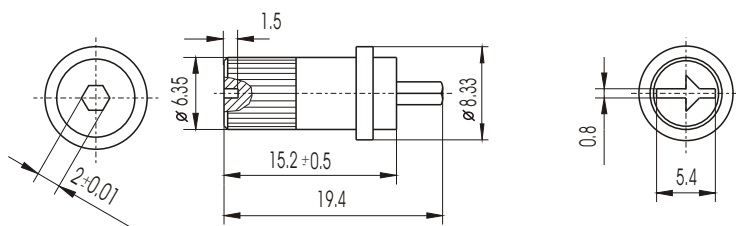

Shafts Colour	Code
White	88 131 446
Black	88 131 489
Red	88 131 502

PNZ10ZA, PNZ11ZA, PNCZ10ZA, PNCZ11ZA potentiometers shaft (STYLE 3)

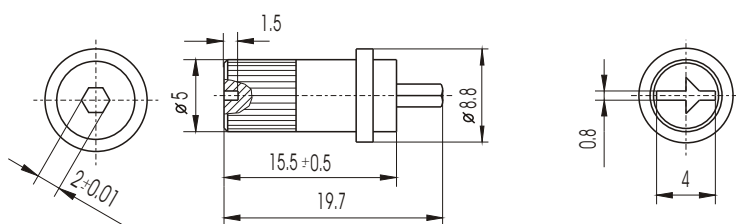

Shafts Colour	Code
White	88 131 544
Black	88 131 589
Red	88 131 776



Packaging / Ser. PNZ - PNCZ / 10mm

Potentiometers PNZ10Z PNCZ10Z are packaged in plastic tubes, compatible with automatic assembly equipment.

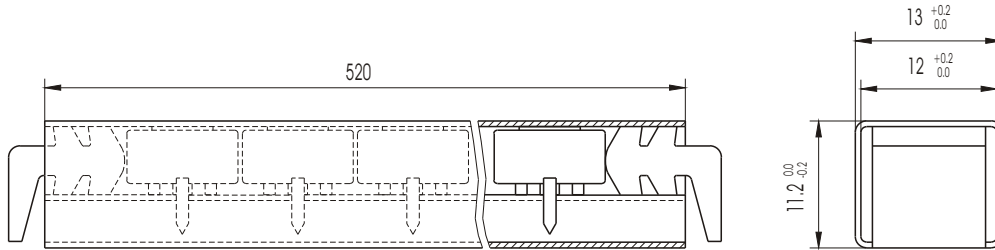

50 pcs

Ordering Example / Ser. PNZ / 6mm, 10mm

