

LED

35W  
4500 lm  
41W  
3500 lm  
t  
25.000 h  
T<sub>k</sub>  
2.700-5.000 K  
15.000 X  
<0,5 s



# 833526

230V / 50Hz~

1 x LED-Board 36V DC /35W

2,4GHz  
17,8dBm

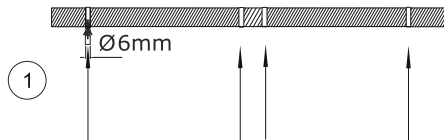

1

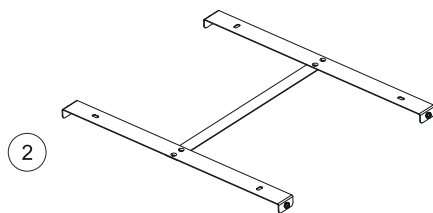

2

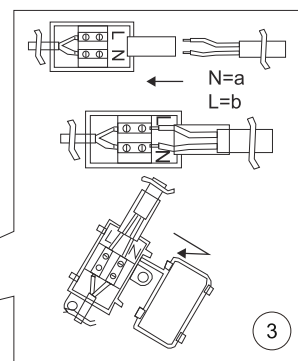
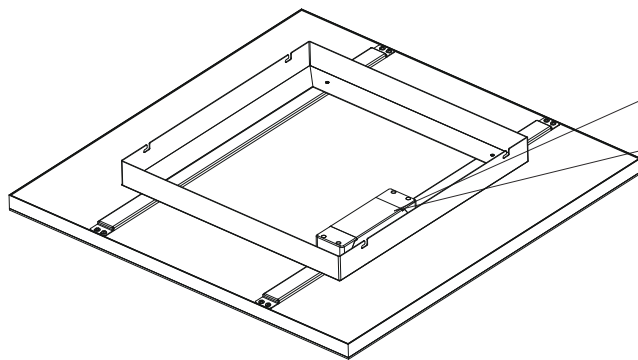

3

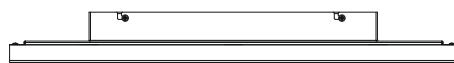
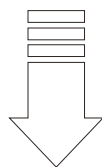

4

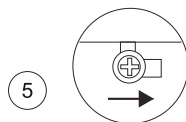

5

Das Gerät erfüllt die grundlegenden Anforderungen der Richtlinie 2014/53/EU (Radio Equipment Directive) des Europäischen Parlaments und des Rates der europäischen Union vom 16.04.2014 über Funkanlagen.

Die vollständige Konformitätserklärung kann bei der unten stehenden Internet-Adresse aufgerufen werden.

This device fulfils the fundamental requirements of Directive 2014/53/EU (Radio Equipment Directive) of the European Parliament and of the Council of the European Union dated 16.04.2014 on items of radio equipment.

The full declaration of conformity can be accessed at the Internet-address given below.

Paul Neuhaus

Paul Neuhaus GmbH  
Olakenweg 36 · 59457 Werl  
Germany  
E-mail: kundenservice@neuhaus-group.de  
<https://scm.paul-neuhaus.de/public/conformity/>