



Meaningful Innovation.

WEEE Number: 80133970

INSTRUCTION MANUAL

SOLAR LED WALL LIGHT WITH SENSOR



03 YEAR
WARRANTY*
IP65
RATING

INTRODUCTION

Thank you for selecting and buying V-TAC product. V-TAC will serve you the best. Please read these instructions carefully before starting the installation and keep this manual handy for future reference. If you have any other query, please contact our dealer or local vendor from whom you have purchased the product. They are trained and ready to serve you at the best. The warranty is valid for 3 years from the date of purchase. The warranty does not apply to damage caused by incorrect installation or abnormal wear and tear. The company gives no warranty against damage to any surface due to incorrect removal and installation of the product. The products are suitable for 10-12 Hours Daily operation. Usage of product for 24 Hours a day would void the warranty. This product is warranted for manufacturing defects only.



This marking indicates that this product should not be disposed of with other household wastes.



Caution, risk of electric shock.



MULTI-LANGUAGE MANUAL QR CODE

Please scan the QR code to access the manual in multiple languages.

TECHNICAL DATA

| | |
|---------------------|--|
| MODEL | VT-425 / VT-426 / VT-413 |
| SKU | 23004 / 23005 / 23006 |
| LUMENS | 2200 LM |
| POWER | 15W |
| LEDs | SMD 2835x84 pcs |
| MONO SOLAR PANEL | DC 4.5V, 5.8W |
| BATTERY PACK | 32700, 3.2V, 6000mAh, 19.2Wh |
| RADAR SENSOR | 120° / 8 Meter |
| BEAM ANGLE | 360° |
| WORK MODES | SENSOR MODE; Keep Lighting Mode |
| CHARNGING TIME | 7 Hours strong sunshine to fully charge |
| LIGHTING TIME | Upto 80 Hours |
| INSTALLATION HEIGHT | 2-3 Meters |
| LIGHTING AREA | 80m ² |
| HOUSING MATERIAL | ABS+PC, Anti-UV, Anti-Oxidant, Fireproof |
| LAMP DIMENSION | Wall Light 257x288.5x206.5mm Pillar Light 257x257x217mm Garden Light 257x257x879.7mm |
| PACKING | Wall Light: 1 x Solar Lamp, 1 x Base, 4 x Expansion Plugs & Screws, 1 x Anti-theft Screw, 1 x User Manual Pillar Light: 1 x Solar Lamp, 1 x Base, 3 x Expansion Plugs & Screws, 1 x User Manual Garden Light: 1 x Solar Lamp, 1 x Pole, 1 x Base, 7 x Screws, 1 x User Manual |
| WARRANTY | 3 Years |

WARNING

1. This is a solar powered lamp, please install the solar panel in a location where can get enough sunshine.
2. Please note the lighting time depends on sunshine duration & working mode.
3. The On/Off button on the lamp is power-off switch, helpful to save power consumption. Also the lamp can still get solar charge at day time when the lamp is turned off.
4. Built-in intelligent IC is with over-charge and over-discharge protection, safe & durable.
5. The lamp is equipped with an internal battery pack, which is replaceable. If any need, please contact seller for correct new battery pack.
6. Non-professionals please do not disassemble the lamp.
7. Please do not dispose the battery with household garbage to avoid explosion.

RoHS



UK
CA

TWO OPTIONAL WORKING MODES

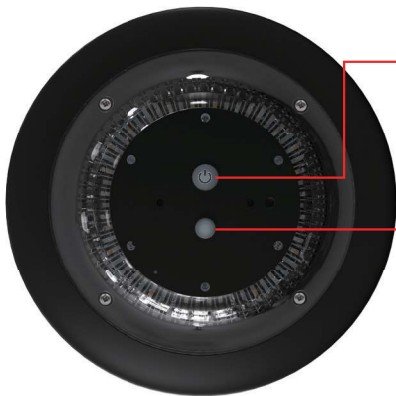

ON/OFF/Switch Woke Mode

1. Press the button 1st time, lamp flashes once and turns on to Sensor Mode.
2. Press the button 2nd time, lamp flashes twice and turns to Keep Lighting Mode.
3. Press the button 3rd time, lamp turns off.

Switch Lighting CCT

Please press this button to switch the color temperature.

SENSOR MODE

Lamp automatically lights up at night, automatically turns to 60% brightness when motion is detected in the range $\leq 8\text{mtrs}$, then dim to lower brightness after 20 seconds of no motion.

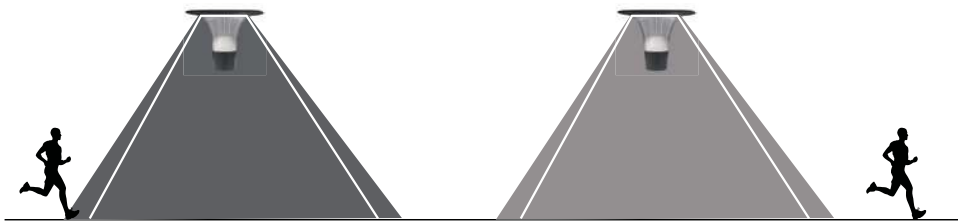

KEEP LIGHTING MODE

Lamp automatically light up at night and keep full brightness, after 5 hours it turns to Sensor Mode.

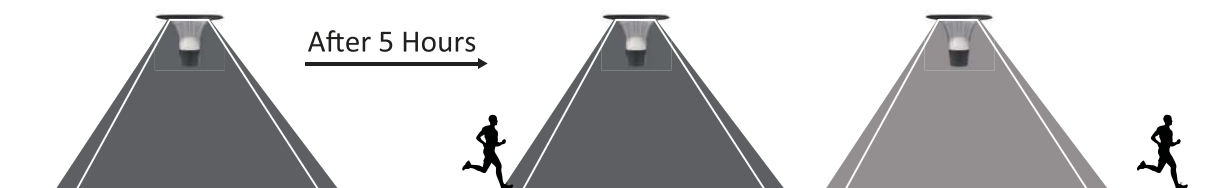

WIDE APPLICATION

Flexibly used for Yard, Garage, Warehouse, Garden, Holiday Resort, Farm, Industrial Park, etc.

INSTALLATION

WALL LIGHT INSTALLATION

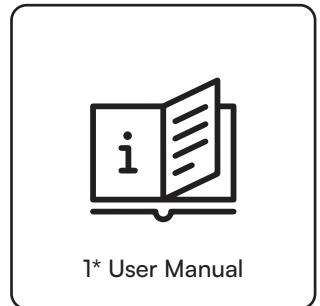
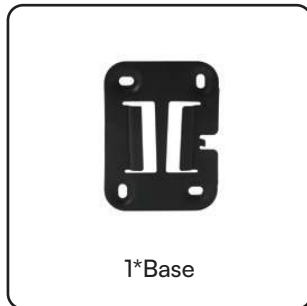

1. Drill 4 holes with a diameter of $\phi 6\text{mm}$ and a depth of 45mm, fix the expansion plugs into the holes, then lock the base on the wall with screws (M4*40mm).
2. Press the bigger button on the lamp to turn on the lamp and select desired work mode; press the smaller button to select desired lighting color.
3. Slide the lamp onto the base.
4. Tighten the anti-theft screw (M3*25mm) to fix the lamp to the base.

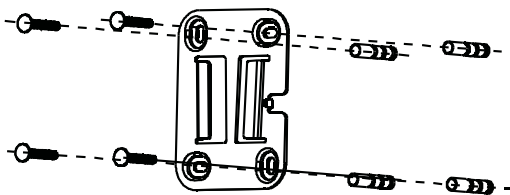

①

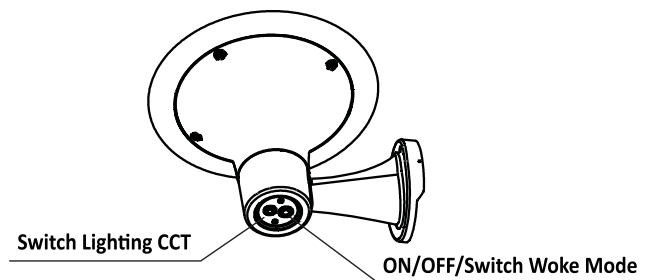

②

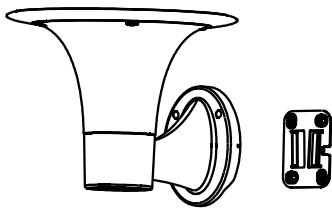

③

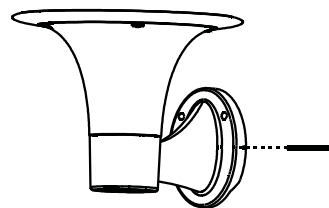

④

PILLAR LIGHT INSTALLATION

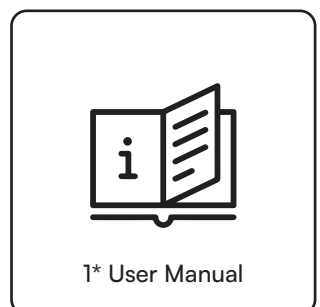

BEFORE INSTALLATION

PLEASE NOTE THE RADAR(📶) SHOULD TOWARD THE DESIRED AREA TO BE SENSED.

1. Drill 3 holes with a diameter of $\phi 8\text{mm}$ and a depth of 65mm , fix the expansion plugs into the holes, then lock the base with screws ($\text{M}5 \times 55\text{mm}$).
2. Press the bigger button on the lamp to turn on the lamp and select desired work mode; press the smaller button to select desired lighting color.
3. Put the lamp into the clamping slot and rotate it clockwise to fix well.

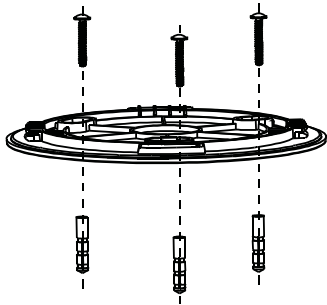

①

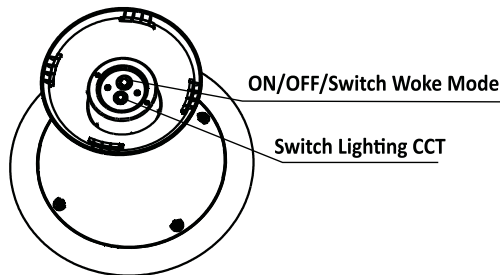

②

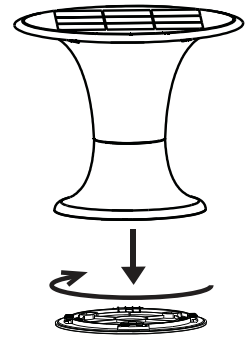

③

GARDEN LIGHT INSTALLATION



1* Lamp

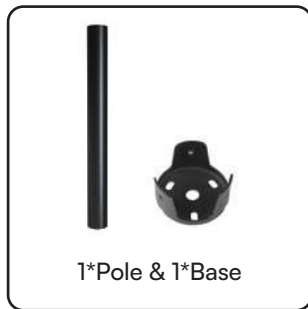

1* Pole & 1* Base



3*Screw

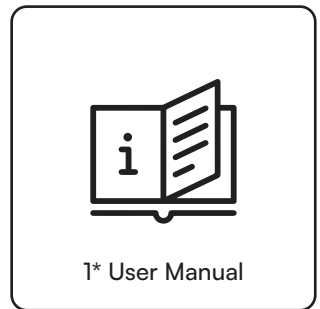

1* User Manual

BEFORE INSTALLATION

PLEASE NOTE THE RADAR(📶) SHOULD TOWARD THE DESIRED AREA TO BE SENSED.

1. Drill 3 holes with a diameter of $\phi 8\text{mm}$ and a depth of 65mm , fix the expansion bolts into the holes, then lock the base on the ground with flat washers, spring washers and nuts.
2. Press the bigger button on the lamp to turn on the lamp and select desired work mode; press the smaller button to select desired lighting color.
3. Insert the lamp into the pole with right direction, and fix it with screw ($\text{M}4 \times 8\text{mm}$).
4. Insert the pole (with the lamp installed) into the base, and then fix it with 3 screws ($\text{M}5 \times 10\text{mm}$).

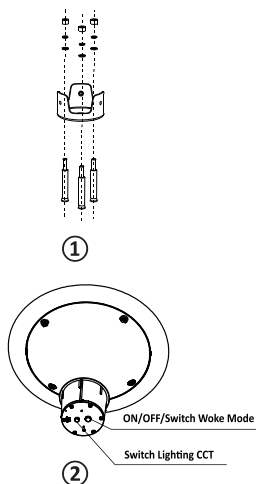

①

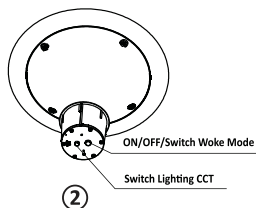

②

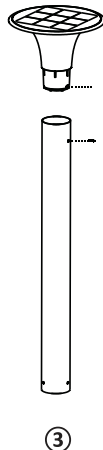

③

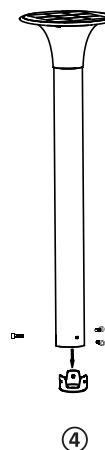

④