

INSTRUCTION MANUAL LED BACKLIT RECESSED PANEL



TECHNICAL DATA

MODEL	SKU	SHAPE	WATTS	LUMENS	BEAM ANGLE	IP RATING	CRI	BODY TYPE	TOTAL CURRENT	INPUT POWER	LIFE SPAN	ON/OFF CYCLE	DIMENSION (LxWxH)
VT-61003	7855 10477 7856 10478 7857 10479	ROUND	3W	330LM	Sphere 360°	IP20	>80	PLASTIC	26mA	AC:220-240 50/60Hz	20000H	>15000	φ90.5x28mm
		SQUARE											90.2x90.2x28.2mm
VT-61006	7858 10480 7859 10481 7860 10482	ROUND	6W	660LM	Sphere 360°	IP20	>80	PLASTIC	36mA	AC:220-240 50/60Hz	20000H	>15000	φ120.5x28.4mm
		SQUARE											120.5x120.5x28.4mm
VT-61012	7861 10483 7862 10484 7863 10485	ROUND	12W	1200LM	Sphere 360°	IP20	>80	PLASTIC	71mA	AC:220-240 50/60Hz	20000H	>15000	φ170.8x28.4mm
		SQUARE											170.8x170.8x28.4mm
VT-61018	7864 10486 7865 10487 7866 10488	ROUND	18W	1850LM	Sphere 360°	IP20	>80	PLASTIC	103mA	AC:220-240 50/60Hz	20000H	>15000	φ220.8x28.9mm
		SQUARE		1980LM									220.4x220.4x28.8mm
VT-61024	7867 10489 7868 10490 7869 10491	ROUND	24W	2500LM	Sphere 360°	IP20	>80	PLASTIC	160mA	AC:220-240 50/60Hz	20000H	>15000	φ296x29.1mm
		SQUARE		2640LM									295x295x28.6mm

'This product contains a light source of energy efficiency class <F/E>', where <F/E> shall be replaced by the energy efficiency class of the contained light source.

INTRODUCTION & WARRANTY

Thank you for selecting and buying V-TAC product. V-TAC will serve you the best. Please read these instructions carefully before starting the installation and keep this manual handy for future reference. If you have any another query, please contact our dealer or local vendor from whom you have purchased the product. They are trained and ready to serve you at the best. The warranty is valid for 2 years from the date of purchase. The warranty does not apply to damage caused by incorrect installation or abnormal wear and tear. The company gives no warranty against damage to any surface due to incorrect removal and installation of the product. The products are suitable for 10-12 Hours Daily operation. Usage of product for 24 Hours a day would void the warranty. This product is warranted for manufacturing defects only.

WARNING

- Please make sure to turn off the power before starting the installation.
- Installation must be performed by a certified person.
- The light source of this luminaire is not replaceable, when the light source reaches its end of life the whole luminaire should be replaced.
- For Indoor use only
- If the external flexible cable or cord of this luminaire is damaged, it shall be exclusively replaced by the manufacturer or his service agent or a similar qualified person in order to avoid a hazard.
- Method of attachment of the cable or cord such that any replacement can only be made by the manufacturer, his service agent or similar qualified person.



**MULTI-LANGUAGE
MANUAL QR CODE**
Please scan the QR code to access the manual in multiple languages.



This marking indicates that this product should not be disposed of with other household wastes.



Caution, risk of electric shock.

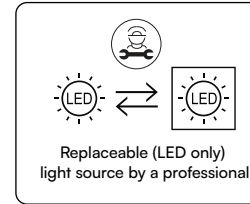

Points de collecte sur www.quefairemesdechets.fr
Privilégiez la réparation ou le don de votre appareil !

ATTENTION!

Do not look directly at LED light beam. Product can only be supplied by rated voltage or voltage within the range provided. It's forbidden to use the product with damaged protective cover. Product must not be used in unfavorable conditions, e.g. dust, water, moisture, vibrations, explosive air atmosphere, fumes, or chemical fumes, etc. In the area of strong electromagnetic interference, the functioning of the product may be disrupted.

USAGE GUIDELINES/MAINTENANCE

Any maintenance work must be performed when the power supply is cut off and the product has cooled down. Clean only with soft and dry cloths. Do not use chemical detergents. Do not cover the product. Ensure free air access. Product may heat up to a higher temperature.

MOUNTING

Read the manual before mounting. Mounting should be performed by a qualified electrician. Exercise caution. Product has a protective contact /terminal. Failure to connect the protective lead may lead to electric shock. Mounting diagram: see pictures. Check for proper mechanical fastening and connection to electrical power prior to first use.

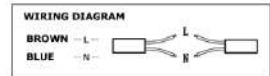

RECESSED PANEL INSTALLATION DIAGRAM

ROUND PANEL	3W	6W	12W	18W	24W
INSTALLATION HOLE SIZE	φ80 (77-82mm)	φ110 (107-112mm)	φ155 (150-155mm)	φ205 (200-205mm)	φ280 (275-280mm)

1. Cut a hole using an appropriate tool according to the cut-out size.
2. Switch OFF the power & Connect AC: 220-240V voltage with terminals.
3. Hold the two clips back against the panel light and push it into the hole. Allow the springs to pull the light up to the ceiling.
4. Check whether the lamp is flat and electrified.
5. Clean the lamp with clean cloth.
6. Switch on the power and test the light.

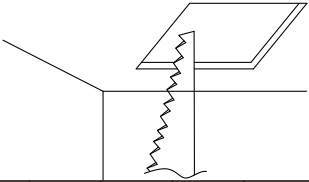

SQUARE PANEL	3W	6W	12W	18W	24W
INSTALLATION HOLE SIZE	80*80 (75-80mm)	110*110 (105-110mm)	155*155 (150-155mm)	205*205 (200-205mm)	280*280 (275-280mm)

1. Cut a hole using an appropriate tool according to the cut-out size.

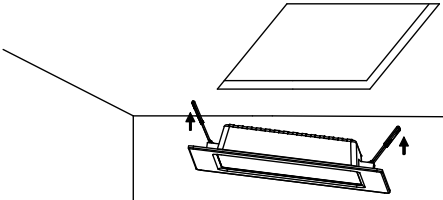

3. Hold the two clips back against the panel light and push it into the hole. Allow the springs to pull the light up to the ceiling.

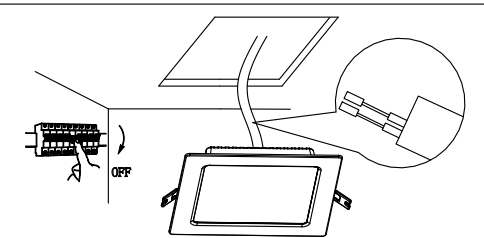

2. Switch OFF the power & Connect AC: 220-240V voltage with terminals.

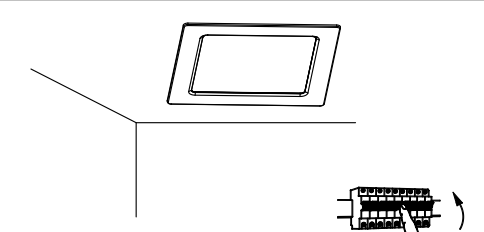

4. Check whether the lamp is flat and electrified.
5. Clean the lamp with clean cloth.
6. Switch on the power and test the light.

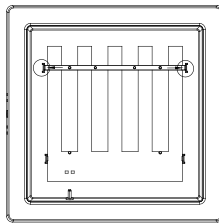

4. Press the buckle outwards, remove the aluminum substrate pressing strip from the bayonet, and remove the pressing strip. This step is only required for 24W panel light, other items are not required.

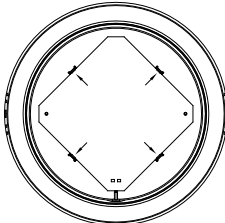

5. Press the buckle outwards, remove the aluminum substrate from the buckle, and remove the light source board.

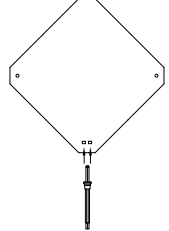

6. Take out two-cord cable (wire diameter 18-22AWG) and insert it into the plug-in terminal. Connect the external power supply for testing.

DISASSEMBLY DIAGRAM

(For Market surveillance team only)

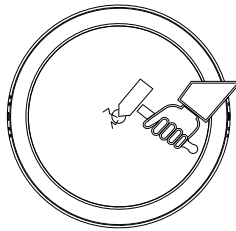

1. Power off, tap the central area of the diffusion plate with a pointed tool, and take out the cracked diffusion plate

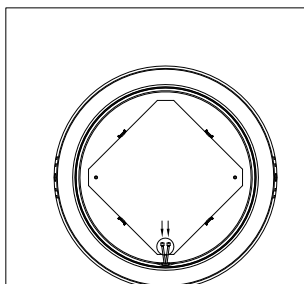

2. Remove the power wire from the plug terminal

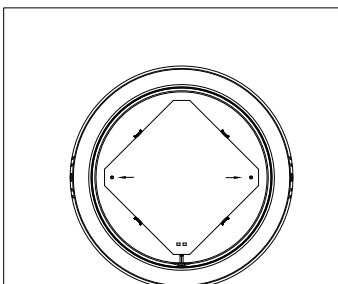

3. If there is no hot melt column in the lamp body or the hot melt column is not hot melt, this step will be adjusted without treatment. If the hot-melt column has been fused to fix the aluminum substrate, cut the hot-melt part of the hot-melt point with diagonal pliers.



IN CASE OF ANY QUERY/ISSUE WITH THE PRODUCT, PLEASE REACH OUT TO US AT: SUPPORT@V-TAC.EU
FOR MORE PRODUCTS RANGE, INQUIRY PLEASE CONTACT OUR DISTRIBUTOR OR NEAREST DEALERS. V-TAC
EUROPE LTD. BULGARIA, PLOVDIV 4000, BUL.L.KARAVELOW 9B

РЪКОВОДСТВО ЗА УПОТРЕБА ПАНЕЛ ЗА ВГРАЖДАНЕ С LED ПОДСВЕТКА



ТЕХНИЧЕСКИ ДАННИ

МОДЕЛ	SKU	SHAPE	WATTS	LUMENS	ЪГЪЛ НА ЛЪЧА	IP РЕЙТИНГ	CRI	ТИП НА КАРОСЕ РИЯТА	ОБЩО ПОСТ ОЯННО	ВХОДНА СИЛА	ПРОДЪЛ ЖИТЕЛНОСТ НА ЖИВОТА	ЦИКЪЛ НА ВКЛЮЧВАНЕ/ИЗКЛЮЧВАНЕ	РАЗМЕРИ (LxWxH)
VT-61003	7855 10477 7856 10478 7857 10479	ROUND	3W	330LM	Sphere 360°	IP20	>80	PLASTIC	26mA	AC:220-240 50/60Hz	20000H	>15000	φ90.5x28mm
		SQUARE											90.2x90.2x28.2mm
VT-61006	7858 10480 7859 10481 7860 10482	ROUND	6W	660LM	Sphere 360°	IP20	>80	PLASTIC	36mA	AC:220-240 50/60Hz	20000H	>15000	φ120.5x28.4mm
		SQUARE											120.5x120.5x28.4mm
VT-61012	7861 10483 7862 10484 7863 10485	ROUND	12W	1200LM	Sphere 360°	IP20	>80	PLASTIC	71mA	AC:220-240 50/60Hz	20000H	>15000	φ170.8x28.4mm
		SQUARE											170.8x170.8x28.4mm
VT-61018	7864 10486 7865 10487 7866 10488	ROUND	18W	1850LM	Sphere 360°	IP20	>80	PLASTIC	103mA	AC:220-240 50/60Hz	20000H	>15000	φ220.8x28.9mm
		SQUARE		1980LM									220.4x220.4x28.8mm
VT-61024	7867 10489 7868 10490 7869 10491	ROUND	24W	2500LM	Sphere 360°	IP20	>80	PLASTIC	160mA	AC:220-240 50/60Hz	20000H	>15000	φ296x29.1mm
		SQUARE		2640LM									295x295x28.6mm

"Този продукт съдържа светлинен източник с клас на енергийна ефективност <F/E>", където <F/E> се заменя с класа на енергийна ефективност на съдържащия се светлинен източник.

ВЪВЕДЕНИЕ И ГАРАНЦИЯ

Благодарим ви, че избрахте и закупихте продукт на V-TAC. V-TAC ще ви служи по най-добрия начин. Моля, прочетете внимателно тези инструкции, преди да започнете инсталацията, и пазете това ръководство под ръка за бъдещи справки. Ако имате някакви други въпроси, моля, свържете се с нашия дилър или с местния продавач, от когото сте закупили продукта. Те са обучени и са готови да ви обслужат по най-добрия начин. Гаранцията е валидна за срок от 2 години от датата на закупуване. Гаранцията не важи за повреди, причинени от неправилен монтаж или необичайно износване. Фирмата не дава гаранция за повреди на повърхности, дължащи се на неправилно демонтиране и инсталиране на продукта. Продуктите са подходящи за 10-12-часова ежедневна работа. Използването на продукта в продължение на 24 часа на ден води до отпадане на гаранцията. Този продукт има гаранция само за производствени дефекти.

ПРЕДУПРЕЖДЕНИЕ

- Моля, уверете се, че сте изключили захранването, преди да започнете монтажа.
- Монтажът трябва да се извърши от сертифицирано лице.
- Светлинният източник на това осветително тяло не може да се заменя, когато светлинният източник достигне края на живота си, трябва да се смени цялото осветително тяло.
- Само за вътрешна употреба
- Ако външният гъвкав кабел или шнур на това осветително тяло е повреден, той трябва да бъде подменен изключително от производителя или негов сервизен агент, или от подобно квалифицирано лице, за да се избегне опасност.
- Методът на закрепване на кабела или шнура е такъв, че подмяната може да се извърши само от производителя, неговия сервизен представител или подобно квалифицирано лице.



Тази маркировка показва, че този продукт не трябва да се изхвърля заедно с други битови отпадъци.



Внимание, риск от токов удар.

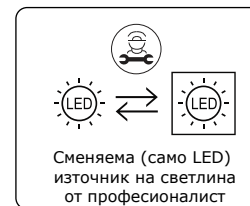

Сменяема (само LED) източник на светлина от професионалист



FR Cet appareil, ses accessoires et cordons se recyclent

À DÉPOSER EN MAGASIN À DÉPOSER EN DÉCHÈTERIE



Points de collecte sur www.quefairedemesdechets.fr
Privilégiez la réparation ou le don de votre appareil!

ВНИМАНИЕ!

Не гледайте директно към светлинния лъч на светодиода. Продуктът може да бъде захранван само с номинално напрежение или с напрежение в рамките на предоставения диапазон. Забранено е използването на продукта с повреден защитен капак. Продуктът не трябва да се използва при неблагоприятни условия, напр. прах, вода, влага, вибрации, експлозивна въздушна атмосфера, изпарения или химически изпарения и др. В зона със силни електромагнитни смущения функционирането на продукта може да бъде нарушено.

НАСОКИ ЗА ИЗПОЛЗВАНЕ/ПОДДРЪЖКА

Всички дейности по поддръжката трябва да се извършват, когато захранването е прекъснато и продуктът е изстинал. Почиствайте само с меки и сухи кърпи. Не използвайте химически почистващи препарати. Не покривайте продукта. Осигурете свободен достъп на въздух. Продуктът може да се нагрее до по-висока температура.

МОНТИРАНЕ

Прочетете ръководството за употреба преди монтажа. Монтажът трябва да се извърши от квалифициран електротехник. Бъдете внимателни. Продуктът е снабден със защитен контакт /терминал. Несвързването на защитния проводник може да доведе до токов удар. Схема за монтаж: вижте снимките. Преди първата употреба проверете за правилно свързване към електрическото захранване.

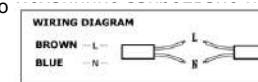

МОНТАЖНА СХЕМА НА ПАНЕЛ ЗА ВГРАЖДАНЕ

КРЪГЪЛ ПАНЕЛ	3W	6W	12W	18W	24W
РАЗМЕР НА МОНТАЖНИЯ ОТВОР	φ80 (77-82mm)	φ110 (107-112mm)	φ155 (150-155mm)	φ205 (200-205mm)	φ280 (275-280mm)

- Изрежете отвор с помощта на подходящ инструмент в съответствие с размера на изреза.
- Изключете захранването и свържете Променил ток: 220-240V напрежение с клеми.
- Задръжте двете щипки обратно към светлинния панел и го вкарайте в отвора. Оставете пружините да издърпат лампата към тавана.
- Проверете дали лампата е плоска и наелектризирана.
- Почистете лампата с чиста кърпа.
- Включете захранването и тествайте светлината.

КВАДРАТЕН ПАНЕЛ	3W	6W	12W	18W	24W
РАЗМЕР НА МОНТАЖНИЯ ОТВОР	80*80 (75-80mm)	110*110 (105-110mm)	155*155 (150-155mm)	205*205 (200-205mm)	280*280 (275-280mm)

1. Изрежете дупка с помощта на подходящ инструмент в съответствие с размера на изрязания отвор.

2. Изключете захранването и свържете Променив ток: 220-240V напрежение с клещи.

3. Задръжте двете шипки обратно към светлинния панел и го вкарвайте в отвора. Оставете пружините да издърпат лампата към тавана.

4. Проверете дали лампата е плоска и наелектризирана.

5. Почистете лампата с чиста кърпа.

6. Включете захранването и тествайте светлината.

4. Натиснете ключалката навън, отстранете притискащата лента на алуминиевия субстрат от байонета и отстранете притискащата лента. Тази стъпка е необходима само за 24W панелна светлина, други елементи не са необходими.

5. Натиснете ключалката навън, отстранете алуминиевата подложка от ключалката и извадете платката на светлинния източник.

6. Извадете двужилен кабел (диаметър на проводника 18-22AWG) и го поставете в клемата за включване. Свържете външното захранване за тестване.

СХЕМА ЗА РАЗГЛОБЯВАНЕ

(Само за екипа за наблюдение на пазара)

1. Изключете захранването, докоснете централната област на дифузионната плоча с остър инструмент и извадете напуканата дифузионна плоча

2. Премахнете захранващия проводник от клемата на щепсела

3. Ако в тялото на лампата няма колона за горещо разтопяване или колоната за горещо разтопяване не е горещо разтопена, тази стъпка ще бъде коригирана без обработка. Ако колоната за горещо разтопяване е била разтопена, за да фиксира алуминиевия субстрат, изрежете частта за горещо разтопяване на точката за горещо разтопяване с диагонални клещи.



IN CASE OF ANY QUERY/ISSUE WITH THE PRODUCT, PLEASE REACH OUT TO US AT: SUPPORT@V-TAC.EU FOR MORE PRODUCTS RANGE, INQUIRY PLEASE CONTACT OUR DISTRIBUTOR OR NEAREST DEALERS. V-TAC EUROPE LTD. BULGARIA, PLOVDIV 4000, BUL.L.KARAVELOW 9B

INSTRUCTION MANUAL LED BACKLIT RECESSED PANEL



TECHNICAL DATA

MODEL	SKU	SHAPE	WATTS	LUMENS	BEAM ANGLE	IP RATING	CRI	BODY TYPE	TOTAL CURRENT	INPUT POWER	LIFE SPAN	ON/OFF CYCLE	DIMENSION (LxWxH)
VT-61003	7855 10477	ROUND	3W	330LM	Sphere 360°	IP20	>80	PLASTIC	26mA	AC:220-240 50/60Hz	20000H	>15000	φ90.5x28mm
	7856 10478	SQUARE											90.2x90.2x28.2mm
VT-61006	7858 10480	ROUND	6W	660LM	Sphere 360°	IP20	>80	PLASTIC	36mA	AC:220-240 50/60Hz	20000H	>15000	φ120.5x28.4mm
	7859 10481	SQUARE											120.5x120.5x28.4mm
VT-61012	7861 10483	ROUND	12W	1200LM	Sphere 360°	IP20	>80	PLASTIC	71mA	AC:220-240 50/60Hz	20000H	>15000	φ170.8x28.4mm
	7862 10484	SQUARE											170.8x170.8x28.4mm
VT-61018	7864 10486	ROUND	18W	1850LM	Sphere 360°	IP20	>80	PLASTIC	103mA	AC:220-240 50/60Hz	20000H	>15000	φ220.8x28.9mm
	7865 10487	SQUARE		1980LM									220.4x220.4x28.8mm
VT-61024	7867 10489	ROUND	24W	2500LM	Sphere 360°	IP20	>80	PLASTIC	160mA	AC:220-240 50/60Hz	20000H	>15000	φ296x29.1mm
	7868 10490	SQUARE		2640LM									296x296x28.6mm

'This product contains a light source of energy efficiency class <F/E>', where <F/E> shall be replaced by the energy efficiency class of the contained light source.

INTRODUCTION & WARRANTY

Thank you for selecting and buying V-TAC product. V-TAC will serve you the best. Please read these instructions carefully before starting the installation and keep this manual handy for future reference. If you have any another query, please contact our dealer or local vendor from whom you have purchased the product. They are trained and ready to serve you at the best. The warranty is valid for 2 years from the date of purchase. The warranty does not apply to damage caused by incorrect installation or abnormal wear and tear. The company gives no warranty against damage to any surface due to incorrect removal and installation of the product. The products are suitable for 10-12 Hours Daily operation. Usage of product for 24 Hours a day would void the warranty. This product is warranted for manufacturing defects only.

WARNING

- Please make sure to turn off the power before starting the installation.
- Installation must be performed by a certified person.
- The light source of this luminaire is not replaceable, when the light source reaches its end of life the whole luminaire should be replaced.
- For Indoor use only
- If the external flexible cable or cord of this luminaire is damaged, it shall be exclusively replaced by the manufacturer or his service agent or a similar qualified person in order to avoid a hazard.
- Method of attachment of the cable or cord such that any replacement can only be made by the manufacturer, his service agent or similar qualified person.



**MULTI-LANGUAGE
MANUAL QR CODE**
Please scan the QR code to access the manual in multiple languages.



This marking indicates that this product should not be disposed of with other household wastes.



Caution, risk of electric shock.

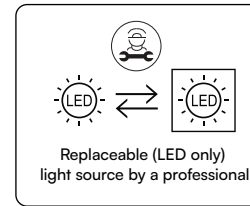

FR
Cet appareil, ses accessoires et cordons se recyclent
À DÉPOSER EN MAGASIN À DÉPOSER EN DÉCHÈTERIE
OU

Points de collecte sur www.quefairemesdechets.fr
Privilégiez la réparation ou le don de votre appareil !

ATTENTION!

Do not look directly at LED light beam. Product can only be supplied by rated voltage or voltage within the range provided. It's forbidden to use the product with damaged protective cover. Product must not be used in unfavorable conditions, e.g. dust, water, moisture, vibrations, explosive air atmosphere, fumes, or chemical fumes, etc. In the area of strong electromagnetic interference, the functioning of the product may be disrupted.

USAGE GUIDELINES/MAINTENANCE

Any maintenance work must be performed when the power supply is cut off and the product has cooled down. Clean only with soft and dry cloths. Do not use chemical detergents. Do not cover the product. Ensure free air access. Product may heat up to a higher temperature.

MOUNTING

Read the manual before mounting. Mounting should be performed by a qualified electrician. Exercise caution. Product has a protective contact /terminal. Failure to connect the protective lead may lead to electric shock. Mounting diagram: see pictures. Check for proper mechanical fastening and connection to electrical power prior to first use.

RECESSED PANEL INSTALLATION DIAGRAM

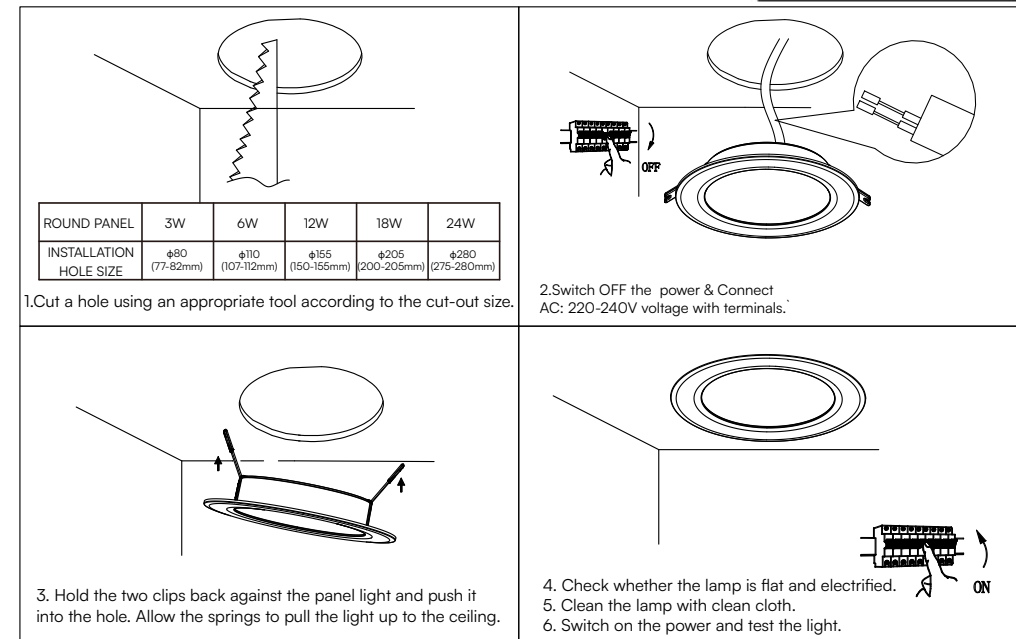
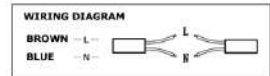

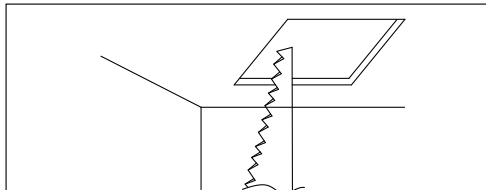

SQUARE PANEL	3W	6W	12W	18W	24W
INSTALLATION HOLE SIZE	80*80 (75-80mm)	110*110 (105-110mm)	155*155 (150-155mm)	205*205 (200-205mm)	280*280 (275-280mm)

1. Cut a hole using an appropriate tool according to the cut-out size.

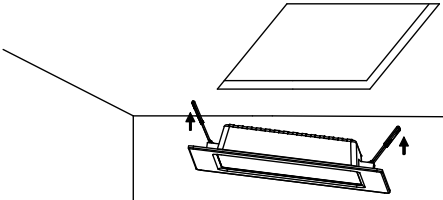

3. Hold the two clips back against the panel light and push it into the hole. Allow the springs to pull the light up to the ceiling.

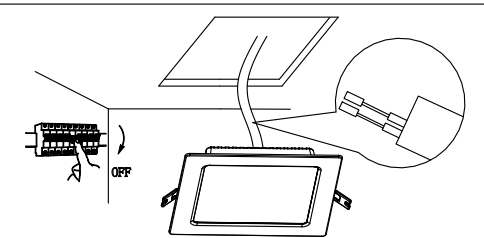

2. Switch OFF the power & Connect AC: 220-240V voltage with terminals.

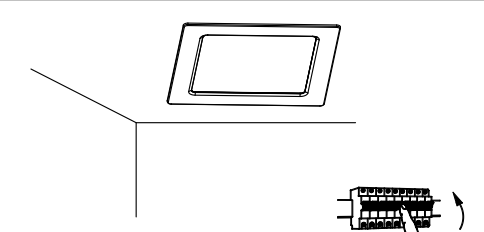

4. Check whether the lamp is flat and electrified.
5. Clean the lamp with clean cloth.
6. Switch on the power and test the light.

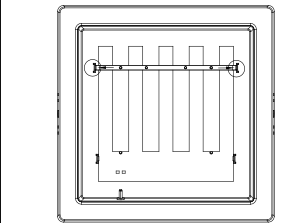

4. Press the buckle outwards, remove the aluminum substrate pressing strip from the bayonet, and remove the pressing strip. This step is only required for 24W panel light, other items are not required.

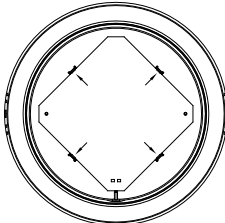

5. Press the buckle outwards, remove the aluminum substrate from the buckle, and remove the light source board.

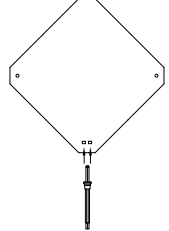

6. Take out two-cord cable (wire diameter 18-22AWG) and insert it into the plug-in terminal. Connect the external power supply for testing.

DISASSEMBLY DIAGRAM

(For Market surveillance team only)

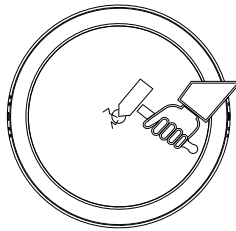

1. Power off, tap the central area of the diffusion plate with a pointed tool, and take out the cracked diffusion plate

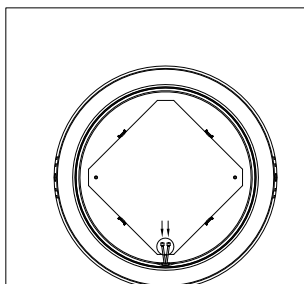

2. Remove the power wire from the plug terminal

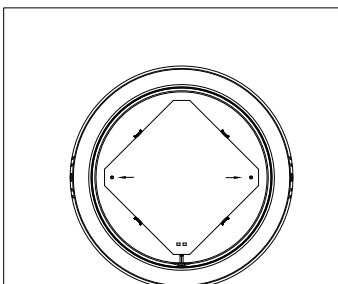

3. If there is no hot melt column in the lamp body or the hot melt column is not hot melt, this step will be adjusted without treatment. If the hot-melt column has been fused to fix the aluminum substrate, cut the hot-melt part of the hot-melt point with diagonal pliers.



IN CASE OF ANY QUERY/ISSUE WITH THE PRODUCT, PLEASE REACH OUT TO US AT: SUPPORT@V-TAC.EU
FOR MORE PRODUCTS RANGE, INQUIRY PLEASE CONTACT OUR DISTRIBUTOR OR NEAREST DEALERS. V-TAC
EUROPE LTD. BULGARIA, PLOVDIV 4000, BUL.L.KARAVELOW 9B

NÁVOD K POUŽITÍ LED PODSVÍCENÝ ZAPUŠTĚNÝ PANEL



TECHNICKÉ ÚDAJE

MODEL	SKU	SHAPE	WATTS	LUMENS	ÚHEL PAPSRSKU	IP RATING	CRI	TYP TĚLA	CELKEM BĚŽNÝ	VSTUPNÍ NAPÁJENÍ	ROZSAH ŽIVOTA	CYKLUS ZAPNUTÍ/VYPNUTÍ	ROZMĚRY (DxŠxV)
VT-61003	7855 10477 7856 10478 7857 10479	ROUND	3W	330LM	Sphere 360°	IP20	>80	PLASTIC	26mA	AC:220-240 50/60Hz	20000H	>15000	φ90.5x28mm
		SQUARE											90.2x90.2x28.2mm
VT-61006	7858 10480 7859 10481 7860 10482	ROUND	6W	660LM	Sphere 360°	IP20	>80	PLASTIC	36mA	AC:220-240 50/60Hz	20000H	>15000	φ120.5x28.4mm
		SQUARE											120.5x120.5x28.4mm
VT-61012	7861 10483 7862 10484 7863 10485	ROUND	12W	1200LM	Sphere 360°	IP20	>80	PLASTIC	71mA	AC:220-240 50/60Hz	20000H	>15000	φ170.8x28.4mm
		SQUARE											170.8x170.8x28.4mm
VT-61018	7864 10486 7865 10487 7866 10488	ROUND	18W	1850LM	Sphere 360°	IP20	>80	PLASTIC	103mA	AC:220-240 50/60Hz	20000H	>15000	φ220.8x28.9mm
		SQUARE		1980LM									220.4x220.4x28.8mm
VT-61024	7867 10489 7868 10490 7869 10491	ROUND	24W	2500LM	Sphere 360°	IP20	>80	PLASTIC	160mA	AC:220-240 50/60Hz	20000H	>15000	φ296x29.1mm
		SQUARE		2640LM									295x295x28.6mm

"Tento výrobek obsahuje zdroj světla třídy energetické účinnosti <F/E>", kde <F/E> se nahradí třídou energetické účinnosti obsaženého zdroje světla.

ÚVOD A ZÁRUKA

Děkujeme, že jste si vybrali a zakoupili produkt V-TAC. V-TAC vám bude sloužit co nejlépe. Před zahájením instalace si pozorně přečtěte tento návod a uschovejte jej pro budoucí použití. V případě dalších dotazů se obraťte na našeho prodejce nebo místního prodejce, od kterého jste výrobek zakoupili. Jsou vyškoleni a připraveni vám co nejlépe posloužit. Záruka je platná po dobu 2 let od data zakoupení. Záruka se nevztahuje na poškození způsobené nesprávnou instalací nebo abnormálním opotřebením. Společnost neposkytuje záruku na poškození jakéhokoli povrchu v důsledku nesprávné demontáže a instalace výrobku. Výrobky jsou vhodné pro 10-12 hodin denního provozu. Používání výrobku po dobu 24 hodin denně by znamenalo ztrátu záruky. Na tento výrobek se vztahuje záruka pouze na výrobní vady.

VAROVÁNÍ

- Před zahájením instalace nezapomeňte vypnout napájení.
- Instalaci musí provádět certifikovaná osoba.
- Světelný zdroj tohoto svítidla není vyměnitelný, po skončení životnosti světelného zdroje je třeba vyměnit celé svítidlo.
- Pouze pro vnitřní použití
- Pokud dojde k poškození vnějšího ohebného kabelu nebo šňůry tohoto svítidla, musí být vyměněn výhradně výrobcem nebo jeho servisním zástupcem nebo podobně kvalifikovanou osobou, aby se předešlo nebezpečí.
- Způsob upevnění kabelu nebo šňůry musí být takový, aby jakoukoli výměnu mohl provést pouze výrobce, jeho servisní zástupce nebo podobně kvalifikovaná osoba.



Toto označení znamená, že tento výrobek by neměl být likvidován společně s ostatními odpady z domácnosti.



Pozor, nebezpečí úrazu elektrickým proudem.

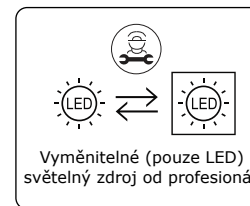

FR Cet appareil, ses accessoires et cordons se recyclent

À DÉPOSER EN MAGASIN À DÉPOSER EN DÉCHÈTERIE OU

Points de collecte sur www.quefairemesdechets.fr
Privilégiez la réparation ou le don de votre appareil !

POZOR!

Nedívejte se přímo na světelný paprsek LED. Výrobek může být napájen pouze jmenovitým napětím nebo napětím v uvedeném rozsahu. Je zakázáno používat výrobek s poškozeným ochranným krytem. Výrobek se nesmí používat v nepříznivých podmínkách, např. v prachu, vodě, vlhkosti, vibracích, výbušném ovzduší, výparech nebo chemických výparech apod. V oblasti silného elektromagnetického rušení může dojít k narušení funkce výrobku.

POKYNY PRO POUŽÍVÁNÍ/ÚDRŽBU

Veškeré údržbářské práce se musí provádět po odpojení napájení a vychladnutí výrobku. Čistěte pouze měkkými a suchými utěrkami. Nepoužívejte chemické čisticí prostředky. Výrobek nezakrývejte. Zajistěte volný přístup vzduchu. Výrobek se může zahřát na vyšší teplotu.

MONTÁŽ

Před montáží si přečtěte návod k obsluze. Montáž by měl provádět kvalifikovaný elektrikář. Dbejte zvýšené opatrnosti. Výrobek má ochranný kontakt /koncovku. Nepřipojení ochranného vodiče může vést k úrazu elektrickým proudem. Montážní schéma: viz obrázky. Před prvním použitím zkontrolujte správné mechanické upevnění a připojení k elektrickému napájení.

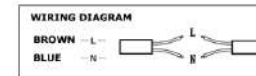

INSTALAČNÍ SCHÉMA ZAPUŠTĚNÉHO PANELU

KRUHOVÝ PANEL	3W	6W	12W	18W	24W
INSTALACE	φ80	φ110	φ155	φ205	φ280
VELIKOST OTVORU (77-82mm)	107-112mm	150-155mm	200-205mm	275-280mm	

1. Vhodným nástrojem vyříznete otvor podle velikosti výřezu.
2. Vypněte napájení a připojte AC: 220-240V napětí se svorkami.
3. Přidržte obě svorky zpět u světelného panelu a zasuňte je do otvoru. Nechte pružiny, aby světlo vytáhly ke stropu.
4. Zkontrolujte, zda je lampa plochá a elektrifikovaná.
5. Vyčistěte lampu čistým hadříkem.
6. Zapněte napájení a vyzkoušejte světlo.

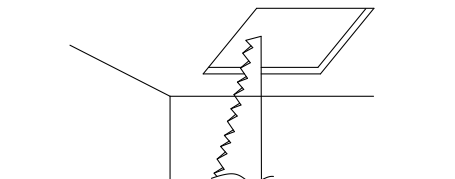

ČTVERCOVÝ PANEL	3W	6W	12W	18W	24W
VELIKOST INSTALAČNÍHO OTVORU	80*80 (75-80mm)	110*110 (105-110mm)	155*155 (150-155mm)	205*205 (200-205mm)	280*280 (275-280mm)

1. Vyřízněte otvor pomocí vhodného nástroje podle velikosti výřezu.

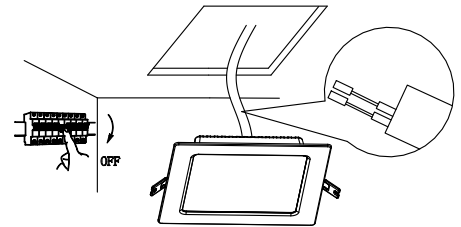

2. Vypněte napájení a připojte AC: 220-240V napětí se svorkami.

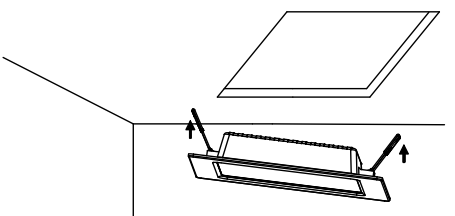

3. Přidrže obě svorky zpět u světelného panelu a zasuňte je do otvoru. Nechte pružiny, aby světlo vytáhly ke stropu.

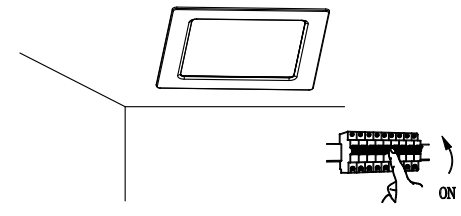

4. Zkontrolujte, zda je lampa plochá a elektrifikovaná.
5. Vyčistěte lampu čistým hadříkem.
6. Zapněte napájení a vyzkoušejte světlo.

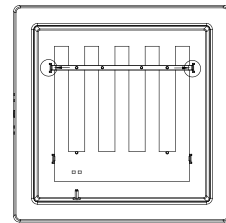

4. Stiskněte sponu směrem ven, odstraňte přítlačnou lištu hliníkového substrátu z bajonetu a odstraňte přítlačnou lištu. Tento krok je nutný pouze pro 24W panelové světlo, ostatní položky nejsou nutné.

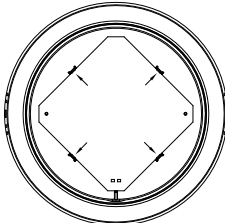

5. Stiskněte sponu směrem ven, odstraňte hliníkový substrát ze spony a vyjměte desku světelného zdroje.

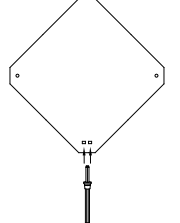

6. Vyjměte dvoušňůrový kabel (průměr drátu 18-22AWG) a vložte jej do zásuvné svorky. Připojte externí zdroj napájení pro testování.

DEMONTÁŽNÍ SCHÉMA

(Pouze pro tým pro dohled nad trhem)

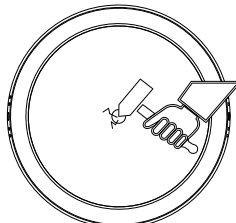

1. Vypněte napájení, poklepejte špičatým nástrojem na střední část difuzní desky a vyjměte prasklou difuzní desku.

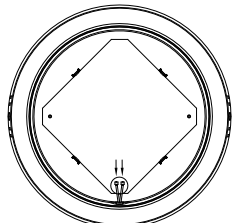

2. Odpojte napájecí vodič od zástrčkové svorky

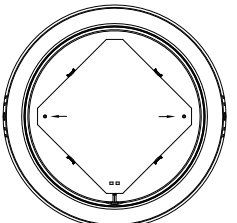

3. Pokud v tělese lampy není žádný sloupec horké taveniny nebo sloupec horké taveniny není horký, bude tento krok upraven bez ošetření. Pokud byl sloupec horké taveniny roztaven pro upevnění hliníkového podkladu, odřízněte část horké taveniny hrotu horké taveniny pomocí diagonálních kleští.



IN CASE OF ANY QUERY/ISSUE WITH THE PRODUCT, PLEASE REACH OUT TO US AT: SUPPORT@V-TAC.EU FOR MORE PRODUCTS RANGE, INQUIRY PLEASE CONTACT OUR DISTRIBUTOR OR NEAREST DEALERS. V-TAC EUROPE LTD. BULGARIA, PLOVDIV 4000, BUL.L.KARAVELOW 9B

MANUEL D'INSTRUCTIONS PANNEAU ENCASTRÉ RÉTRO-ÉCLAIRÉ PAR LED



DONNÉES TECHNIQUES

MODÈLE	SKU	FORME	WATTS	LUMENS	FENÊTRE ANGLE	IP NOTATION	CRI	CORPS TYPE	TOTAL ACTUEL	ENTRÉE ALIMENTATION	VIE SPAN	ON/OFF CYCLE	DIMENSION (LxWxH)
VT-61003	7855 10477	ROUND	3W	330LM	Sphere 360°	IP20	>80	PLASTIC	26mA	AC:220-240 50/60Hz	20000H	>15000	φ90.5x28mm
	7856 10478	SQUARE											90.2x90.2x28.2mm
VT-61006	7858 10480	ROUND	6W	660LM	Sphere 360°	IP20	>80	PLASTIC	36mA	AC:220-240 50/60Hz	20000H	>15000	φ120.5x28.4mm
	7859 10481	SQUARE											120.5x120.5x28.4mm
VT-61012	7861 10483	ROUND	12W	1200LM	Sphere 360°	IP20	>80	PLASTIC	71mA	AC:220-240 50/60Hz	20000H	>15000	φ170.8x28.4mm
	7862 10484	SQUARE											170.8x170.8x28.4mm
VT-61018	7864 10486	ROUND	18W	1850LM	Sphere 360°	IP20	>80	PLASTIC	103mA	AC:220-240 50/60Hz	20000H	>15000	φ220.8x28.9mm
	7865 10487	SQUARE		1980LM									220.4x220.4x28.8mm
VT-61024	7867 10489	ROUND	24W	2500LM	Sphere 360°	IP20	>80	PLASTIC	160mA	AC:220-240 50/60Hz	20000H	>15000	φ296x29.1mm
	7868 10490	SQUARE		2640LM									295x295x28.6mm

Ce produit contient une source lumineuse de classe d'efficacité énergétique <F/E>, où <F/E> est remplacé par la classe d'efficacité énergétique de la source lumineuse contenue.

INTRODUCTION ET GARANTIE

Merci d'avoir choisi et acheté un produit V-TAC. V-TAC vous servira au mieux. Veuillez lire attentivement ces instructions avant de commencer l'installation et conservez ce manuel à portée de main pour pouvoir vous y référer ultérieurement. Si vous avez d'autres questions, veuillez contacter notre revendeur ou le vendeur local auprès duquel vous avez acheté le produit. Ils sont formés et prêts à vous servir au mieux. La garantie est valable pendant 2 ans à compter de la date d'achat. La garantie ne s'applique pas aux dommages causés par une installation incorrecte ou une usure anormale. L'entreprise ne garantit pas les dommages causés à toute surface par un démontage et une installation incorrects du produit. Les produits conviennent pour un fonctionnement quotidien de 10 à 12 heures. L'utilisation du produit pendant 24 heures par jour annule la garantie. Ce produit est garanti pour les défauts de fabrication uniquement.

AVERTISSEMENT

- Veuillez à couper le courant avant de commencer l'installation.
- L'installation doit être effectuée par une personne certifiée.
- La source lumineuse de ce luminaire n'est pas remplaçable. Lorsque la source lumineuse atteint sa fin de vie, l'ensemble du luminaire doit être remplacé.
- Pour une utilisation à l'intérieur uniquement
- Si le câble ou le cordon flexible externe de ce luminaire est endommagé, il doit être remplacé exclusivement par le fabricant, son agent de service ou une personne qualifiée similaire afin d'éviter tout danger.
- La méthode de fixation du câble ou du cordon est telle que tout remplacement ne peut être effectué que par le fabricant, son agent de service ou une personne qualifiée similaire.



Ce marquage indique que ce produit ne doit pas être éliminé avec les autres déchets ménagers.



Attention, risque de choc électrique.

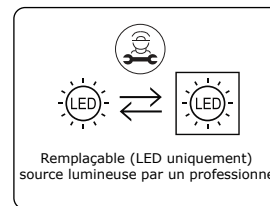

FR Cet appareil, ses accessoires et cordons se recyclent



Points de collecte sur www.quefairemesdechets.fr
Privilégiez la réparation ou le don de votre appareil !

ATTENTION !

Ne pas regarder directement le faisceau lumineux de la LED. Le produit ne peut être alimenté que par la tension nominale ou la tension comprise dans la plage fournie. Il est interdit d'utiliser le produit avec une housse de protection endommagée. Le produit ne doit pas être utilisé dans des conditions défavorables, telles que la poussière, l'eau, l'humidité, les vibrations, les atmosphères explosives, les fumées ou les vapeurs chimiques, etc. Dans une zone de fortes interférences électromagnétiques, le fonctionnement du produit peut être perturbé.

DIRECTIVES D'UTILISATION/ENTRETIEN

Toute opération d'entretien doit être effectuée lorsque l'alimentation électrique est coupée et que le produit a refroidi. Nettoyez uniquement avec des chiffons doux et secs. Ne pas utiliser de détergents chimiques. Ne pas couvrir le produit. Veillez à ce que l'air soit libre. Le produit peut atteindre une température plus élevée.

MONTAGE

Lisez le manuel avant de procéder au montage. Le montage doit être effectué par un électricien qualifié. Soyez prudent. Le produit est doté d'un contact/terminal de protection. Le fait de ne pas connecter le fil de protection peut entraîner un choc électrique. Schéma de montage : voir les images. Vérifier la bonne fixation mécanique et la connexion à l'alimentation électrique avant la première



DIAGRAMME D'INSTALLATION DU PANNEAU ENCASTRÉ

PANNEAU ROND	3W	6W	12W	18W	24W
INSTALLATION	φ80	φ110	φ155	φ205	φ280
TAILLE DU TROU	(77-82mm)	(107-112mm)	(150-155mm)	(200-205mm)	(275-280mm)

- découper un trou à l'aide d'un outil approprié en fonction de la taille de la découpe.
- éteindre l'appareil et le brancher AC : 220-240V tension avec les bornes.
- Maintenez les deux clips contre le panneau lumineux et poussez-le dans le trou, dans le trou. Laissez les ressorts tirer la lampe jusqu'au plafond.
- Vérifier si la lampe est plate et électriifiée.
- Nettoyer la lampe avec un chiffon propre.
- Mettez l'appareil sous tension et testez la lumière.

PANNEAU CARRÉ	3W	6W	12W	18W	24W
INSTALLATION	80*80	110*110	155*155	205*205	280*280
TAILLE DU TROU	(75-80mm)	105-110mm	150-155mm	200-205mm	275-280mm

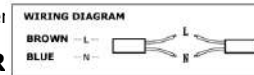
1. découper un trou à l'aide d'un outil approprié en fonction de la taille de la découpe.

2. éteindre l'appareil et le brancher AC : 220-240V tension avec les bornes.

3. Maintenez les deux clips contre le panneau lumineux et poussez-le dans le trou. Laissez les ressorts tirer la lampe jusqu'au plafond.

4. Vérifier si la lampe est plate et électrifiée.
5. Nettoyer la lampe avec un chiffon propre.
6. Mettez l'appareil sous tension et testez la lumière.

4. appuyez sur la boucle vers l'extérieur, retirez la bande de pression du substrat en aluminium de la baïonnette et retirez la bande de pression. Cette étape n'est nécessaire que pour le panneau lumineux de 24W, les autres éléments ne sont pas nécessaires.

5. appuyez sur la boucle vers l'extérieur, retirez le substrat en aluminium de la boucle et retirez la carte de la source lumineuse.

6. retirer le câble à deux brins (diamètre du fil 18-22AWG) et l'insérer dans la borne enfichable. Brancher l'alimentation externe pour les tests.

DIAGRAMME DE DÉMONTAGE

(Réservé à l'équipe de surveillance du marché)

1. éteindre l'appareil, frapper la zone centrale de la plaque de diffusion à l'aide d'un outil pointu et retirer la plaque de diffusion fissurée

2. retirer le câble d'alimentation de la borne de la fiche

3. s'il n'y a pas de colonne thermofusible dans le corps de la lampe ou si la colonne thermofusible n'est pas thermofusible, cette étape sera ajustée sans traitement. si la colonne thermofusible a été fusionnée pour fixer le substrat en aluminium, couper la partie thermofusible du point thermofusible à l'aide d'une pince diagonale.



IN CASE OF ANY QUERY/ISSUE WITH THE PRODUCT, PLEASE REACH OUT TO US AT: SUPPORT@V-TAC.EU FOR MORE PRODUCTS RANGE, INQUIRY PLEASE CONTACT OUR DISTRIBUTOR OR NEAREST DEALERS. V-TAC EUROPE LTD. BULGARIA, PLOVDIV 4000, BUL.L.KARAVELOW 9B

GEBRAUCHSANWEISUNG

LED-HINTERGRUNDBELEUCHTETE EINBAUPLATTE



TECHNISCHE DATEN

MODELL	SKU	SHAPE	WATTS	LUMENS	STRAHLE NWINKEL	IP RATING	CRI	KÖRPER -TYP	GESAMT AKTUELL	EINGANG SLEISTUNG	LEBEN SDAUER	EIN/AUS -ZYKLUS	DIMENSION (LxWxH)
VT-61003	7855 10477	ROUND	3W	330LM	Sphere 360°	IP20	>80	PLASTIC	26mA	AC:220-240 50/60Hz	20000H	>15000	φ90.5x28mm
	7856 10478	SQUARE											90.2x90.2x28.2mm
VT-61006	7858 10480	ROUND	6W	660LM	Sphere 360°	IP20	>80	PLASTIC	36mA	AC:220-240 50/60Hz	20000H	>15000	φ120.5x28.4mm
	7859 10481	SQUARE											120.5x120.5x28.4mm
VT-61012	7861 10483	ROUND	12W	1200LM	Sphere 360°	IP20	>80	PLASTIC	71mA	AC:220-240 50/60Hz	20000H	>15000	φ170.8x28.4mm
	7862 10484	SQUARE											170.8x170.8x28.4mm
VT-61018	7864 10486	ROUND	18W	1850LM	Sphere 360°	IP20	>80	PLASTIC	103mA	AC:220-240 50/60Hz	20000H	>15000	φ220.8x28.9mm
	7865 10487	SQUARE		1980LM									220.4x220.4x28.8mm
VT-61024	7867 10489	ROUND	24W	2500LM	Sphere 360°	IP20	>80	PLASTIC	160mA	AC:220-240 50/60Hz	20000H	>15000	φ296x29.1mm
	7868 10490	SQUARE		2640LM									295x295x28.6mm

Dieses Produkt enthält eine Lichtquelle der Energieeffizienzklasse <F/E>“, wobei <F/E> durch die Energieeffizienzklasse der enthaltenen Lichtquelle zu ersetzen ist.

EINFÜHRUNG & GARANTIE

Vielen Dank, dass Sie ein V-TAC-Produkt ausgewählt und gekauft haben. V-TAC wird Ihnen die besten Dienste leisten. Bitte lesen Sie diese Anweisungen sorgfältig durch, bevor Sie mit der Installation beginnen, und bewahren Sie diese Anleitung zum späteren Nachschlagen auf. Sollten Sie weitere Fragen haben, wenden Sie sich bitte an unseren Händler oder an den lokalen Verkäufer, von dem Sie das Produkt gekauft haben. Sie sind geschult und bereit, Sie bestmöglich zu bedienen. Die Garantie gilt für 2 Jahre ab dem Kaufdatum. Die Garantie gilt nicht für Schäden, die durch unsachgemäße Installation oder abnormalen Verschleiß verursacht wurden. Das Unternehmen übernimmt keine Garantie für Schäden an Oberflächen, die durch unsachgemäßen Aus- und Einbau des Produkts entstehen. Die Produkte sind für einen täglichen Betrieb von 10-12 Stunden geeignet. Bei einer Nutzung des Produkts über 24 Stunden pro Tag erlischt die Garantie. Für dieses Produkt wird nur eine Garantie für Herstellungsfehler gewährt.

WARNUNG

- Bitte stellen Sie sicher, dass die Stromversorgung vor Beginn der Installation ausgeschaltet ist.
- Die Installation muss von einer zertifizierten Person durchgeführt werden.
- Die Lichtquelle dieser Leuchte ist nicht austauschbar. Wenn die Lichtquelle ihr Lebensende erreicht hat, sollte die gesamte Leuchte ausgetauscht werden.
- Nur für die Verwendung in Innenräumen
- Wenn die externe flexible Leitung oder das Kabel dieser Leuchte beschädigt ist, muss sie/es ausschließlich vom Hersteller oder seinem Kundendienst oder einer ähnlich qualifizierten Person ersetzt werden, um eine Gefährdung zu vermeiden.
- Die Art der Befestigung des Kabels oder der Leitung muss so beschaffen sein, dass ein Austausch nur vom Hersteller, seinem Kundendienst oder einer ähnlich qualifizierten Person vorgenommen werden kann.



Diese Kennzeichnung weist darauf hin, dass dieses Produkt nicht mit anderen Haushaltsabfällen entsorgt werden darf.



Vorsicht, Gefahr eines Stromschlags.

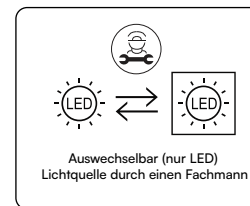

FR
Cet appareil, ses accessoires et cordons se recyclent

À DÉPOSER EN MAGASIN
OU
À DÉPOSER EN DÉCHÈTERIE

Points de collecte sur www.quefairemesdechets.fr
Privilégiez la réparation ou le don de votre appareil!

ACHTUNG!

Schauen Sie nicht direkt in den LED-Lichtstrahl. Das Produkt darf nur mit der Nennspannung oder einer Spannung innerhalb des angegebenen Bereichs betrieben werden. Es ist verboten, das Produkt mit beschädigter Schutzabdeckung zu verwenden. Das Produkt darf nicht unter ungünstigen Bedingungen verwendet werden, wie z.B. Staub, Wasser, Feuchtigkeit, Vibrationen, explosive Luft, Dämpfe oder chemische Dämpfe, etc. Im Bereich starker elektromagnetischer Störungen kann die Funktion des Produkts gestört werden.

NUTZUNGSRICHTLINIEN/WARTUNG

Alle Wartungsarbeiten dürfen nur bei ausgeschalteter Stromversorgung und abgekühltem Gerät durchgeführt werden. Reinigen Sie nur mit weichen und trockenen Tüchern. Verwenden Sie keine chemischen Reinigungsmittel. Decken Sie das Gerät nicht ab. Sorgen Sie für freien Luftzugang. Das Produkt kann sich auf eine höhere Temperatur erhitzen.

MONTAGE

Lesen Sie vor der Montage das Handbuch. Die Montage sollte von einem qualifizierten Elektriker durchgeführt werden. Seien Sie vorsichtig. Das Produkt verfügt über einen Schutzkontakt/Klemme. Wird der Schutzkontakt nicht angeschlossen, besteht die Gefahr eines Stromschlags. Montageschema: siehe Bilder. Überprüfen Sie vor dem ersten Gebrauch die ordnungsgemäße mechanische Befestigung und den Anschluss an die Stromversorgung.

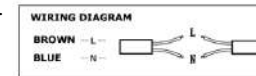

SCHALTPLAN FÜR DEN EINBAU VON UNTERPUTZPLATTEN

RUNDES PANEL	3W	6W	12W	18W	24W
INSTALLATION LOCHGRÖSSE	φ80 (77-82mm)	φ110 (107-112mm)	φ155 (150-155mm)	φ205 (200-205mm)	φ280 (275-280mm)

- ein Loch mit einem geeigneten Werkzeug entsprechend der Ausschnittgröße ausschneiden.
- das Gerät ausschalten und anschließen
AC: 220-240V Spannung mit Klemmen.
- Halten Sie die beiden Clips an der Leuchte fest und drücken Sie sie in das Loch. Lassen Sie die Federn die Leuchte nach oben an die Decke ziehen.
- Prüfen Sie, ob die Lampe flach ist und unter Strom steht.
- Reinigen Sie die Lampe mit einem sauberen Tuch.
- Schalten Sie den Strom ein und testen Sie das Licht.

QUADRATPLATTE	3W	6W	12W	18W	24W
INSTALLATION LOCHGRÖSSE	80*80 (75-80mm)	110*110 (105-110mm)	155*155 (150-155mm)	205*205 (200-205mm)	280*280 (275-280mm)

1. ein Loch mit einem geeigneten Werkzeug ausschneiden entsprechend der Größe des Ausschnitts.

2. das Gerät ausschalten und anschließen.
AC: 220-240V Spannung mit Klemmen.

3. Halten Sie die beiden Klammern an der Leuchte fest und schieben Sie sie in das Loch. Lassen Sie die Federn die Leuchte nach oben an die Decke ziehen.

4. Prüfen Sie, ob die Lampe flach ist und unter Strom steht.
5. Reinigen Sie die Lampe mit einem sauberen Tuch.
6. Schalten Sie den Strom ein und testen Sie das Licht.

4. drücken Sie die Schnalle nach außen, entfernen Sie den Druckstreifen des Aluminiumsubstrats vom Bajonett und nehmen Sie den Druckstreifen ab. Dieser Schritt ist nur für 24W-Panel-Licht erforderlich, andere Elemente sind nicht erforderlich.

5. Drücken Sie die Schnalle nach außen, entfernen Sie das Aluminiumsubstrat von der Schnalle und nehmen Sie die Lichtquellenplatte ab.

Nehmen Sie das zweiadrige Kabel (Drahtdurchmesser 18-22AWG) heraus und stecken Sie es in die Steckklemme. Schließen Sie die externe Stromversorgung zum Testen an.

DEMONTAGESKIZZE

(Nur für das Marktüberwachungsteam)

1. ausschalten, mit einem spitzen Werkzeug auf den mittleren Bereich der Diffusionsplatte klopfen und die gerissene Diffusionsplatte herausnehmen

2. entfernen Sie das Stromkabel von der Steckklemme

3. wenn es keine Heißschmelzsäule im Lampenkörper gibt oder die Heißschmelzsäule nicht heißschmelzend ist, wird dieser Schritt ohne Behandlung angepasst, wenn die Heißschmelzsäule verschmolzen wurde, um das Aluminiumsubstrat zu fixieren, schneiden Sie den Heißschmelzteil der Heißschmelzspitze mit einer diagonalen Zange ab.

WICHTIGE HINWEISE:

- Elektro- und Elektronikgeräte, die zu Abfall geworden sind, werden als Altgeräte bezeichnet. Altgeräte dürfen nicht mit anderem Hausmüll entsorgt werden.
- Besitzer von Altgeräten am Ende der Nutzungsdauer müssen das Gerät bei den von den öffentlichen Entsorgungsträgern oder Händlern eingerichteten Sammelstellen zurückgeben. Diese Rücksendung ist für Sie mit keinen Kosten verbunden.
- Besitzer von Altgeräten sind verpflichtet, Lampen vor der Rückgabe zerstörungsfrei aus dem Altgerät zu entfernen.



- Das Symbol „Gekreuzte Mülltonnen“ weist darauf hin, dass dieses Produkt nicht mit dem anderen Hausmüll entsorgt werden darf und am Ende seiner Lebensdauer vom unsortierten Hausmüll getrennt gesammelt werden muss.
- Bei der Entsorgung von Elektrogeräten auf Deponien oder Halden können Schadstoffe ins Grundwasser gelangen und in die Nahrungskette gelangen und Ihre Gesundheit und Ihr Wohlbefinden schädigen.
- Unter folgendem Link gelangen Sie zum Online-Verzeichnis der Sammel- und Rückgabestellen: <https://www.ear-system.de/ear-verzeichnis/sammel-und-ruecknahmestellen>

RoHS



UK
CA



IN CASE OF ANY QUERY/ISSUE WITH THE PRODUCT, PLEASE REACH OUT TO US AT: SUPPORT@V-TAC.EU
FOR MORE PRODUCTS RANGE, INQUIRY PLEASE CONTACT OUR DISTRIBUTOR OR NEAREST DEALERS. V-TAC
EUROPE LTD. BULGARIA, PLOVDIV 4000, BUL.L.KARAVELOW 9B

ΕΓΧΕΙΡΙΔΙΟ ΟΔΗΓΙΩΝ ΠΑΝΕΛ ΕΣΟΧΗΣ ΜΕ ΟΠΙΣΘΙΟ ΦΩΤΙΣΜΌ LED



ΤΕΧΝΙΚΑ ΣΤΟΙΧΕΙΑ

ΜΟΝΤΕΛΟ	SKU	SHAPE	WATTS	LUMENS	ΓΩΝΙΑ ΔΕΞΜΗΣ	ΡΥΘΜΙΣΗ IP	CRI	ΤΥΠΟΣ ΣΕΛΜΑΤΟΣ	ΣΥΝΟΛΟ ΤΡΕΧΟΥΣΑ	ΙΣΧΥΣ ΕΙΣΟΔΟΥ	ΔΙΑΡΚΕΙΑ ΖΩΗΣ	ΚΥΚΛΟΣ ΕΝΕΡΓΟΠΟΙΗΣΗΣ/ ΑΝΕΝΕΡΓΟΠΟΙΗΣΗΣ	ΔΙΑΣΤΑΣΕΙΣ (LxWxH)
VT-61003	7855 10477 7856 10478 7857 10479	ROUND	3W	330LM	Sphere 360°	IP20	>80	PLASTIC	26mA	AC:220-240 50/60Hz	20000H	>15000	φ90.5x28mm
		SQUARE											90.2x90.2x28.2mm
VT-61006	7858 10480 7859 10481 7860 10482	ROUND	6W	660LM	Sphere 360°	IP20	>80	PLASTIC	36mA	AC:220-240 50/60Hz	20000H	>15000	φ120.5x28.4mm
		SQUARE											120.5x120.5x28.4mm
VT-61012	7861 10483 7862 10484 7863 10485	ROUND	12W	1200LM	Sphere 360°	IP20	>80	PLASTIC	71mA	AC:220-240 50/60Hz	20000H	>15000	φ170.8x28.4mm
		SQUARE											170.8x170.8x28.4mm
VT-61018	7864 10486 7865 10487 7866 10488	ROUND	18W	1850LM	Sphere 360°	IP20	>80	PLASTIC	103mA	AC:220-240 50/60Hz	20000H	>15000	φ220.8x28.9mm
		SQUARE		1980LM									220.4x220.4x28.8mm
VT-61024	7867 10489 7868 10490 7869 10491	ROUND	24W	2500LM	Sphere 360°	IP20	>80	PLASTIC	160mA	AC:220-240 50/60Hz	20000H	>15000	φ296x29.1mm
		SQUARE		2640LM									295x295x28.6mm

"Αυτό το προϊόν περιέχει πηγή φωτός κατηγορίας ενεργειακής απόδοσης <F/E>", όπου το <F/E> αντικαθίσταται από την κατηγορία ενεργειακής απόδοσης της περιεχόμενης πηγής φωτός.

ΕΙΣΑΓΩΓΗ & ΕΓΓΥΗΣΗ

Σας ευχαριστούμε που επιλέξατε και αγοράσατε το προϊόν V-TAC. Η V-TAC θα σας εξυπηρετήσει με τον καλύτερο τρόπο. Παρακαλούμε διαβάστε προσεκτικά αυτές τις οδηγίες πριν ξεκινήσετε την εγκατάσταση και κρατήστε αυτό το εγχειρίδιο πρόχειρο για μελλοντική αναφορά. Εάν έχετε οποιαδήποτε άλλη απορία, παρακαλούμε επικοινωνήστε με τον αντιπρόσωπο μας ή τον τοπικό πωλητή από τον οποίο αγοράσατε το προϊόν. Είναι εκπαιδευμένοι και έτοιμοι να σας εξυπηρετήσουν με τον καλύτερο τρόπο. Η εγγύηση ισχύει για 2 χρόνια από την ημερομηνία αγοράς. Η εγγύηση δεν ισχύει για ζημιές που προκαλούνται από λανθασμένη εγκατάσταση ή μη φυσιολογική φθορά. Η εταιρεία δεν παρέχει καμία εγγύηση για ζημιές σε οποιαδήποτε επιφάνεια λόγω λανθασμένης αφαίρεσης και εγκατάστασης του προϊόντος. Τα προϊόντα είναι κατάλληλα για 10-12 ώρες καθημερινής λειτουργίας. Η χρήση του προϊόντος για 24 ώρες την ημέρα θα ακυρώσει την εγγύηση. Αυτό το προϊόν φέρει εγγύηση μόνο για κατασκευαστικά ελαττώματα.

ΠΡΟΕΙΔΟΠΟΙΗΣΗ

- Βεβαιωθείτε ότι έχετε απενεργοποιήσει το ρεύμα πριν ξεκινήσετε την εγκατάσταση.
- Η εγκατάσταση πρέπει να πραγματοποιείται από πιστοποιημένο άτομο.
- Η φωτεινή πηγή αυτού του φωτιστικού δεν μπορεί να αντικατασταθεί, όταν η φωτεινή πηγή φτάσει στο τέλος της ζωής της θα πρέπει να αντικατασταθεί ολόκληρο το φωτιστικό.
- Μόνο για εσωτερική χρήση
- Εάν το εξωτερικό εύκαμπτο καλώδιο ή το καλώδιο αυτού του φωτιστικού έχει υποστεί ζημιά, πρέπει να αντικαθίσταται αποκλειστικά από τον κατασκευαστή ή τον αντιπρόσωπο σέρβις του ή από παρόμοιο εξειδικευμένο άτομο, προκειμένου να αποφευχθεί κίνδυνος.
- Ο τρόπος στερέωσης του καλωδίου ή του κορδονιού πρέπει να είναι τέτοιος ώστε η αντικατάσταση να μπορεί να γίνει μόνο από τον κατασκευαστή, τον αντιπρόσωπο σέρβις του ή παρόμοιο εξειδικευμένο άτομο.



Η σήμανση αυτή υποδεικνύει ότι το προϊόν αυτό δεν πρέπει να απορριπτεί μαζί με άλλα οικιακά απόβλητα.



Προσοχή, κίνδυνος ηλεκτροπληξίας.

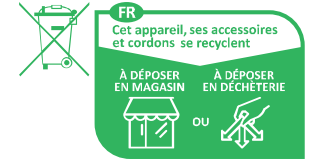
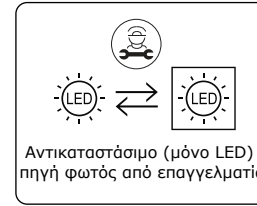

Points de collecte sur www.quefairedemesdechets.fr
Privilégiez la réparation ou le don de votre appareil !

ΠΡΟΣΟΧΗ!

Μην κοιτάτε απευθείας την ακτίνα φωτός LED. Το προϊόν μπορεί να τροφοδοτηθεί μόνο με ονομαστική τάση ή τάση εντός του παρεχόμενου εύρους. Απαγορεύεται η χρήση του προϊόντος με κατεστραμμένο προστατευτικό κάλυμμα. Το προϊόν δεν πρέπει να χρησιμοποιείται σε δυσμενείς συνθήκες, π.χ. σκόνη, νερό, υγρασία, δονήσεις, εκρηκτική ατμόσφαιρα αέρα, αναθυμιάσεις ή χημικές αναθυμιάσεις κ.λπ. Σε περιοχή με ισχυρές ηλεκτρομαγνητικές παρεμβολές, ενδέχεται να διαταραχθεί η λειτουργία του προϊόντος.

ΟΔΗΓΙΕΣ ΧΡΗΣΗΣ/ΣΥΝΤΗΡΗΣΗ

Οποιαδήποτε εργασία συντήρησης πρέπει να εκτελείται όταν έχει διακοπεί η παροχή ρεύματος και το προϊόν έχει κρυώσει. Καθαρίζετε μόνο με μαλακά και στεγνά πανιά. Μην χρησιμοποιείτε χημικά απορρυπαντικά. Μην καλύπτετε το προϊόν. Εξασφαλίστε ελεύθερη πρόσβαση στον αέρα. Το προϊόν ενδέχεται να θερμανθεί σε υψηλότερη θερμοκρασία.

ΤΟΠΟΘΕΤΗΣΗ

Διαβάστε το εγχειρίδιο πριν από την τοποθέτηση. Η τοποθέτηση πρέπει να γίνεται από εξειδικευμένο ηλεκτρολόγο. Προσοχή. Το προϊόν διαθέτει προστατευτική επαφή / ακροδέκτη. Η μη σύνδεση του προστατευτικού καλωδίου μπορεί να οδηγήσει σε ηλεκτροπληξία. Διάγραμμα τοποθέτησης: βλέπε εικόνες. Ελέγξτε τη σωστή μηχανική στερέωση και τη σύνδεση με το ηλεκτρικό ρεύμα πριν από την πρώτη χρήση.

ΔΙΑΓΡΑΜΜΑ ΕΓΚΑΤΑΣΤΑΣΗΣ Π'ΑΝΕΛ ΕΣΟΧΗΣ

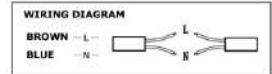

1. Κόψτε μια τρύπα χρησιμοποιώντας ένα κατάλληλο εργαλείο σύμφωνα με το μέγεθος της αποκοπής.

2. Switch OFF το ρεύμα & συνδέστε AC: τάση 220-240V με ακροδέκτες.

ΣΤΡΟΓΓΥΛΟΣ ΠΙΝΑΚΑΣ	3W	6W	12W	18W	24W
ΜΕΓΕΘΟΣ ΟΠΗΣ ΕΓΚΑΤΑΣΤΑΣΗΣ	φ80 (77-82mm)	φ110 (107-112mm)	φ155 (150-155mm)	φ205 (200-205mm)	φ280 (275-280mm)

3. Κρατήστε τα δύο κλιπ πίσω από το φως του πίνακα και σπρώξτε το μέσα στην οπή. Αφήστε τα ελατήρια να τραβήξουν το φως προς την οροφή.

4. Ελέγξτε αν ο λαμπτήρας είναι επίπεδος και ηλεκτρισμένος.
5. Καθαρίστε τον λαμπτήρα με καθαρό πανί.
6. Ενεργοποιήστε το ρεύμα και δοκιμάστε τη λυχνία.

3. Κρατήστε τα δύο κλιπ πίσω από το φως του πίνακα και σπρώξτε το μέσα στην οπή. Αφήστε τα ελατήρια να τραβήξουν το φως προς την οροφή.

4. Ελέγξτε αν ο λαμπτήρας είναι επίπεδος και ηλεκτρισμένος.
5. Καθαρίστε τον λαμπτήρα με καθαρό πανί.
6. Ενεργοποιήστε το ρεύμα και δοκιμάστε τη λυχνία.

ΤΕΤΡΑΓΩΝΟ ΠΙΑΝΕΛ	3W	6W	12W	18W	24W
ΜΕΓΕΘΟΣ ΟΠΗΣ ΕΓΚΑΤΑΣΤΑΣΗΣ	80*80 (75-80mm)	110*110 (105-110mm)	155*155 (150-155mm)	205*205 (200-205mm)	280*280 (275-280mm)

1. Κόψτε μια τρύπα χρησιμοποιώντας ένα κατάλληλο εργαλείο σύμφωνα με το μέγεθος της αποκοπής.

2. Switch OFF το ρεύμα & συνδέστε AC: τάση 220-240V με ακροδέκτες.

3. Κρατήστε τα δύο κλιπ πίσω από το φως του πίνακα και σπρώξτε το μέσα στην οπή. Αφήστε τα ελατήρια να τραβήξουν το φως προς την οροφή.

4. Ελέγξτε αν ο λαμπτήρας είναι επίπεδος και ηλεκτρισμένος.
5. Καθαρίστε τον λαμπτήρα με καθαρό πανί.
6. Ενεργοποιήστε το ρεύμα και δοκιμάστε τη λυχνία.

4. Πιέστε την πόρνη προς τα έξω, αφαιρέστε τη λωρίδα πίεσης του υποστρώματος αλουμινίου από τη μαγνιόετα και αφαιρέστε τη λωρίδα πίεσης. Αυτό το βήμα απαιτείται μόνο για το φωτιστικό πίνακα 24W, άλλα στοιχεία δεν απαιτούνται.

5. Πιέστε την πόρνη προς τα έξω, αφαιρέστε το υπόστρωμα αλουμινίου από την πόρνη και αφαιρέστε την πλακέτα της πηγής φωτός.

6. Βγάλτε το καλώδιο δύο κορδονιών (διάμετρος σύρματος 18-22AWG) και τοποθετήστε το στον ακροδέκτη σύνδεσης. Συνδέστε την εξωτερική παροχή ρεύματος για δοκιμή.

ΔΙΑΓΡΑΜΜΑ ΑΠΟΣΥΝΑΡΜΟΛΟΓΗΣΗΣ (Μόνο για την ομάδα εποπτείας της αγοράς)

1. Απενεργοποιήστε, χτυπήστε την κεντρική περιοχή της πλάκας διάχυσης με ένα αιχμηρό εργαλείο και αφαιρέστε την ραγισμένη πλάκα διάχυσης.

2. Αφαιρέστε το καλώδιο τροφοδοσίας από τον ακροδέκτη του βύσματος.

3. Εάν δεν υπάρχει σήλη θερμού τήγματος στο σώμα του λαμπτήρα ή η σήλη θερμού τήγματος δεν είναι θερμό τήγμα, αυτό το βήμα θα ρυθμιστεί χωρίς επεξεργασία. Εάν η σήλη θερμού τήγματος έχει λιώσει για να στερεώσει το υπόστρωμα αλουμινίου, κόψτε το τμήμα θερμού τήγματος του σημείου θερμού τήγματος με διαγώνια πένσα.



IN CASE OF ANY QUERY/ISSUE WITH THE PRODUCT, PLEASE REACH OUT TO US AT: SUPPORT@V-TAC.EU FOR MORE PRODUCTS RANGE, INQUIRY PLEASE CONTACT OUR DISTRIBUTOR OR NEAREST DEALERS. V-TAC EUROPE LTD. BULGARIA, PLOVDIV 4000, BUL.L.KARAVELOW 9B

HASZNÁLATI ÚTMUTATÓ LED HÁTTÉRVILÁGÍTÁSÚ SÜLLYESZTETT PANEL



TECHNIKAI ADATOK

MODELL	SKU	SHAPE	WATTS	LUMENS	SUGÁR SZÖGE	IP RATING	CRI	BODY TÍPUS	ÖSSZES ÁRAM	BEMENETI TELJESÍTMÉNY	ÉLETSZAK AKASZ	BE/KIKAP CSOLÁSI CIKLUS	MÉRET (LxBxH)
VT-61003	7855 10477 7856 10478 7857 10479	ROUND	3W	330LM	Sphere 360°	IP20	>80	PLASTIC	26mA	AC:220-240 50/60Hz	20000H	>15000	φ90.5x28mm
		SQUARE											90.2x90.2x28.2mm
VT-61006	7858 10480 7859 10481 7860 10482	ROUND	6W	660LM	Sphere 360°	IP20	>80	PLASTIC	36mA	AC:220-240 50/60Hz	20000H	>15000	φ120.5x28.4mm
		SQUARE											120.5x120.5x28.4mm
VT-61012	7861 10483 7862 10484 7863 10485	ROUND	12W	1200LM	Sphere 360°	IP20	>80	PLASTIC	71mA	AC:220-240 50/60Hz	20000H	>15000	φ170.8x28.4mm
		SQUARE											170.8x170.8x28.4mm
VT-61018	7864 10486 7865 10487 7866 10488	ROUND	18W	1850LM	Sphere 360°	IP20	>80	PLASTIC	103mA	AC:220-240 50/60Hz	20000H	>15000	φ220.8x28.9mm
		SQUARE		1980LM									220.4x220.4x28.8mm
VT-61024	7867 10489 7868 10490 7869 10491	ROUND	24W	2500LM	Sphere 360°	IP20	>80	PLASTIC	160mA	AC:220-240 50/60Hz	20000H	>15000	φ296x29.1mm
		SQUARE		2640LM									295x295x28.6mm

"Ez a termék <F/E> energiahatékonysági osztályú fényforrást tartalmaz", ahol az <F/E> helyébe a benne lévő fényforrás energiahatékonysági osztálya lép.

BEVEZETÉS ÉS GARANCIA

Köszönjük, hogy V-TAC terméket választott és vásárolt. A V-TAC a legjobbat fogja nyújtani Önnek. Kérjük, olvassa el figyelmesen ezeket az utasításokat, mielőtt elkezdje a telepítést, és tartsa kéznél ezt a kézikönyvet a későbbi használatra. Ha bármilyen más kérdése van, kérjük, forduljon a kereskedőnkhez vagy a helyi forgalmazóhoz, akitől a terméket vásárolta. Ők képzettek és készen állnak arra, hogy a lehető legjobban kiszolgálják Önt. A garancia a vásárlástól számított 2 évig érvényes. A garancia nem vonatkozik a helytelen telepítés vagy rendellenes elhasználódás okozta károkra. A vállalat nem vállal garanciát a termék helytelen eltávolítása és beszerelése miatt bármely felületen keletkezett károkra. A termékek napi 10-12 órás működésre alkalmasak. A termék napi 24 órás használata esetén a garancia érvényét veszti. A termékre kizárólag gyártási hibák esetén vállalunk garanciát.

FIGYELMEZTETÉS

- A telepítés megkezdése előtt feltétlenül kapcsolja ki a készüléket.
- A telepítést csak szakképzett személy végezheti.
- A lámpatest fényforrása nem cserélhető, ha a fényforrás eléri élettartama végét, az egész lámpatestet ki kell cserélni.
- Csak beltéri használatra.
- Ha a lámpatest külső hajlékony kábele vagy zsinórja megsérül, azt a veszély elkerülése érdekében kizárólag a gyártónak vagy szervizének vagy hasonló képesítéssel rendelkező személynek kell kicserélni.
- A kábel vagy zsinór rögzítési módja olyan, hogy a cserét kizárólag a gyártó, annak szervizügynöke vagy hasonlóan képzett személy végezheti.



Ez a jelölés azt jelzi, hogy ezt a terméket nem szabad más háztartási hulladékkal együtt ártalmatlanítani.



Vigyázat, áramütés veszélye.

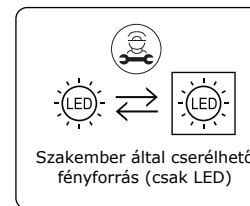

Points de collecte sur www.quefairemesdechets.fr
Privilégiez la réparation ou le don de votre appareil!

FIGYELEM!

Ne nézzen közvetlenül a LED fény sugarába. A termék csak névleges feszültséggel vagy a megadott tartományon belüli feszültséggel táplálható. Tilos a terméket sérült védőburkolattal használni. A terméket nem szabad kedvezőtlen körülmények között használni, pl. por, víz, nedvesség, rezgés, robbanásveszélyes légkör, füst vagy vegyi füst stb. esetén. Erős elektromágneses interferencia területén a termék működése megzavarható.

HASZNÁLATI ÚTMUTATÓ/KARBANTARTÁS

Minden karbantartási munkát akkor kell elvégezni, amikor a tápellátás le van kapcsolva, és a termék lehűlt. Csak puha és száraz ruhával tisztítsa. Ne használjon kémiai tisztítószeret. Ne takarja le a terméket. Biztosítsa a szabad levegőhöz való hozzáférést. A termék magasabb hőmérsékletre melegedhet.

FELSZERELÉS

A felszerelés előtt olvassa el a kézikönyvet. A szerelést szakképzett villanyszerelőnek kell elvégeznie. Legyen óvatos. A termék védőérintkezővel / végződéssel rendelkezik. A védővezeték csatlakoztatásának elmulasztása áramütéshez vezethet. Szerelési ábra: lásd a képeket. Az első használat előtt ellenőrizze a megfelelő mechanikai rögzítést és az elektromos hálózatra való csatlakoztatást

SÜLLYESZTETT PANEL BEÉPÍTÉSI DIAGRAM

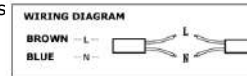

KÖRÖS PANEL	3W	6W	12W	18W	24W
BEÉPÍTÉSI FURAT MÉRETE	φ80 (77-82mm)	φ110 (107-112mm)	φ155 (150-155mm)	φ205 (200-205mm)	φ280 (275-280mm)

1. Vágjon egy lyukat egy megfelelő szerszámmal a kivágás méretének megfelelően.

2. Kapcsolja ki a készüléket és csatlakoztassa AC: 220-240V feszültség a csatlakozókkal.

3. Tartsa a két klipszet hátra a panelfényhez, és tolja be a lyukba. Hagyja, hogy a rugók felhúzzák a lámpát a mennyezetre.

4. Ellenőrizze, hogy a lámpa lapos és áram alatt van-e.
5. Tisztítsa meg a lámpát tiszta ruhával.
6. Kapcsolja be a készüléket, és tesztelje a lámpát.

NÉGYSZÖGŰ PANEL	3W	6W	12W	18W	24W
BEÉPÍTÉSI FURAT MÉRETE	80*80 (75-80mm)	110*110 (105-110mm)	155*155 (150-155mm)	205*205 (200-205mm)	280*280 (275-280mm)

1. Vágjunk lyukat egy megfelelő szerszámmal a kivágott méretnek megfelelően.

2. Kapcsolja ki a készüléket és csatlakoztassa AC: 220-240V feszültség a csatlakozókkal.

3. Tartsa a két klipszet hátra a panelfényhez, és tolja be a lyukba. Hagyja, hogy a rugók felhúzzák a lámpát a mennyezetre.

4. Ellenőrizze, hogy a lámpa lapos és áram alatt van-e.

5. Tisztítsa meg a lámpát tiszta ruhával.

6. Kapcsolja be a készüléket, és tesztelje a lámpát.

4. Nyomja kifelé a csatot, távolítsa el az alumínium aljzat nyomócsíkját a bajonettől, és vegye le a nyomócsíkot. Ez a lépés csak a 24 W-os panelfényhez szükséges, más elemekre nincs szükség.

5. Nyomja kifelé a csatot, távolítsa el az alumínium hordozót a csatról, és vegye ki a fényforrás lapot.

6. Vegye ki a kétsínóros kábelt (vezetékátmérő 18-22AWG), és helyezze be a dugaszolható terminálba. Csatlakoztassa a külső tápegységet a teszteléshez.

SZÉTSZERELÉSI DIAGRAM

(Csak a piacfelügyeleti csoport számára)

1. Kapcsolja ki, érintse meg a diffúziós lemez központi területét egy hegyes szerszámmal, és vegye ki a repedt diffúziós lemezt.

2. Távolítsa el a tápkábelt a dugókapocsból.

3. Ha nincs forró olvadék oszlop a lámpatestben, vagy a forró olvadék oszlop nem forró olvadék, ezt a lépést kezelés nélkül kell beállítani. Ha a forró olvadék oszlop az alumínium hordozó rögzítéséhez olvasztották, átlós fogóval vágja le a forró olvadék-pont forró olvadék részét.



IN CASE OF ANY QUERY/ISSUE WITH THE PRODUCT, PLEASE REACH OUT TO US AT: SUPPORT@V-TAC.EU FOR MORE PRODUCTS RANGE, INQUIRY PLEASE CONTACT OUR DISTRIBUTOR OR NEAREST DEALERS. V-TAC EUROPE LTD. BULGARIA, PLOVDIV 4000, BUL.L.KARAVELOW 9B

MANUALE DI ISTRUZIONI PANNELLO DA INCASSO RETROILLUMINATO A LED



DATI TECNICI

MODELLO	SKU	FORMA	WATTS	LUMENS	RAGGIO ANGOLO	IP VALUT AZIONE	CRI	CORPO TIPO	TOTALE CORRENTE	INGRESSO ALIMENTAZIONE	VITA SPAN	ON/OFF CICLO	DIMENSIONE (LxWxH)
VT-61003	7855 10477	ROUND	3W	330LM	Sphere 360°	IP20	>80	PLASTIC	26mA	AC:220-240 50/60Hz	20000H	>15000	φ90.5x28mm
	7856 10478	SQUARE											90.2x90.2x28.2mm
	7857 10479	SQUARE											
VT-61006	7858 10480	ROUND	6W	660LM	Sphere 360°	IP20	>80	PLASTIC	36mA	AC:220-240 50/60Hz	20000H	>15000	φ120.5x28.4mm
	7859 10481	SQUARE											120.5x120.5x28.4mm
	7860 10482	SQUARE											
VT-61012	7861 10483	ROUND	12W	1200LM	Sphere 360°	IP20	>80	PLASTIC	71mA	AC:220-240 50/60Hz	20000H	>15000	φ170.8x28.4mm
	7862 10484	SQUARE											170.8x170.8x28.4mm
	7863 10485	SQUARE											
VT-61018	7864 10486	ROUND	18W	1850LM	Sphere 360°	IP20	>80	PLASTIC	103mA	AC:220-240 50/60Hz	20000H	>15000	φ220.8x28.9mm
	7865 10487	SQUARE		1980LM									220.4x220.4x28.8mm
	7866 10488	SQUARE											
VT-61024	7867 10489	ROUND	24W	2500LM	Sphere 360°	IP20	>80	PLASTIC	160mA	AC:220-240 50/60Hz	20000H	>15000	φ296x29.1mm
	7868 10490	SQUARE		2640LM									296x296x28.6mm
	7869 10491	SQUARE											

Questo prodotto contiene una sorgente luminosa di classe di efficienza energetica <F/E>, dove <F/E> è sostituito dalla classe di efficienza energetica della sorgente luminosa contenuta.

INTRODUZIONE E GARANZIA

Grazie per aver scelto e acquistato un prodotto V-TAC. V-TAC vi servirà al meglio. Si prega di leggere attentamente le presenti istruzioni prima di iniziare l'installazione e di tenere il manuale a portata di mano per future consultazioni. Per qualsiasi altra domanda, contattare il nostro rivenditore o il venditore locale presso il quale è stato acquistato il prodotto. Sono addestrati e pronti a servirvi al meglio. La garanzia è valida per 2 anni dalla data di acquisto. La garanzia non si applica ai danni causati da un'installazione non corretta o da usura anomala. L'azienda non fornisce alcuna garanzia contro i danni a qualsiasi superficie dovuti a un'errata rimozione e installazione del prodotto. I prodotti sono adatti per un funzionamento di 10-12 ore al giorno. L'utilizzo del prodotto per 24 ore al giorno invalida la garanzia. Questo prodotto è garantito solo per i difetti di fabbricazione.

ATTENZIONE

- Assicurarsi di spegnere l'alimentazione prima di iniziare l'installazione.
- L'installazione deve essere eseguita da una persona certificata.
- La sorgente luminosa di questo apparecchio non è sostituibile; quando la sorgente luminosa raggiunge la fine del suo ciclo di vita, l'intero apparecchio deve essere sostituito.
- Solo per uso interno
- Se il cavo flessibile esterno di questo apparecchio di illuminazione è danneggiato, deve essere sostituito esclusivamente dal produttore o dal suo agente di assistenza o da una persona qualificata simile, al fine di evitare un pericolo.
- Il metodo di fissaggio del cavo o della corda è tale che la sostituzione può essere effettuata solo dal produttore, dal suo agente di assistenza o da una persona qualificata.



Questo marchio indica che questo prodotto non deve essere smaltito con altri rifiuti domestici.



Attenzione, rischio di scosse elettriche.

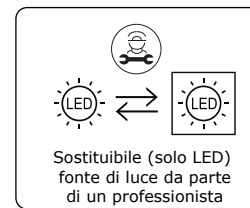

FR Cet appareil, ses accessoires et cordons se recyclent

A DÉPOSER EN MAGASIN A DÉPOSER EN DÉCHÈTERIE



Points de collecte sur www.quefairemesdechets.fr
Privilégiez la réparation ou le don de votre appareil!

ATTENZIONE!

Non guardare direttamente il fascio di luce dei LED. Il prodotto può essere alimentato solo con la tensione nominale o con una tensione compresa nell'intervallo previsto. È vietato utilizzare il prodotto con il coperchio protettivo danneggiato. Il prodotto non deve essere utilizzato in condizioni sfavorevoli, ad esempio polvere, acqua, umidità, vibrazioni, atmosfera esplosiva, fumi o esalazioni chimiche, ecc. In presenza di forti interferenze elettromagnetiche, il funzionamento del prodotto potrebbe essere disturbato.

LINEE GUIDA D'USO/MANUTENZIONE

Qualsiasi intervento di manutenzione deve essere eseguito quando l'alimentazione è interrotta e il prodotto si è raffreddato. Pulire solo con panni morbidi e asciutti. Non utilizzare detergenti chimici. Non coprire il prodotto. Assicurare il libero accesso all'aria. Il prodotto potrebbe riscaldarsi a una temperatura più elevata.

MONTAGGIO

Leggere il manuale prima del montaggio. Il montaggio deve essere eseguito da un elettricista qualificato. Prestare attenzione. Il prodotto è dotato di un contatto/terminale di protezione. Il mancato collegamento del cavo di protezione può provocare scosse elettriche. Schema di montaggio: vedere le immagini. Verificare il corretto fissaggio meccanico e il collegamento all'alimentazione elettrica prima del primo utilizzo.

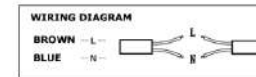

SCHEMA DI INSTALLAZIONE DEL PANNELLO DA INCASSO

PANNELLO ROTONDO	3W	6W	12W	18W	24W
INSTALLAZIONE DIMENSIONE DEL FORO	φ80 (77-82mm)	φ110 (107-112mm)	φ155 (150-155mm)	φ205 (200-205mm)	φ280 (275-280mm)

- Praticare un foro con uno strumento appropriato in base alle dimensioni del foro.
- Spegnere l'alimentazione e collegare AC: tensione 220-240V con terminali.
- Tenere le due clip contro il pannello luminoso e spingerlo nel foro. Lasciare che le molle tirino la luce verso il soffitto.
- Controllare se la lampada è piatta ed elettrificata.
- Pulire la lampada con un panno pulito.
- Accendere l'alimentazione e testare la luce.

PANNELLO QUADRATO	3W	6W	12W	18W	24W
INSTALLAZIONE DIMENSIONE DEL FORO	80*80 (75-80mm)	110*110 105-110mm	155*155 150-155mm	205*205 200-205mm	280*280 275-280mm

1. Praticare un foro con un utensile appropriato in base alle dimensioni del foro.

2. Spegnerne l'alimentazione e collegare AC: tensione 220-240V con terminali.

3. Tenere le due clip contro il pannello luminoso e spingerlo nel foro. nel foro. Lasciare che le molle tirino la luce verso il soffitto.

4. Controllare se la lampada è piatta ed elettrificata.
5. Pulire la lampada con un panno pulito.
6. Accendere l'alimentazione e testare la luce.

4. Premere la fibbia verso l'esterno, rimuovere la striscia di pressione del substrato di alluminio dalla baionetta e rimuovere la striscia di pressione. Questo passaggio è necessario solo per le lampade a pannello da 24W, mentre gli altri elementi non sono necessari.

5. Premere la fibbia verso l'esterno, rimuovere il substrato di alluminio dalla fibbia e rimuovere la scheda della sorgente luminosa.

6. Estrarre il cavo a due conduttori (diametro del filo 18-22AWG) e inserirlo nel terminale a innesto. Collegare l'alimentazione esterna per il test.

SCHEMA DI SMONTAGGIO

(Solo per il team di sorveglianza del mercato)

1. Spegnerne, toccare l'area centrale della piastra di diffusione con uno strumento appuntito ed estrarre la piastra di diffusione incrinata.

2. Rimuovere il cavo di alimentazione dal terminale a spina.

3. Se nel corpo della lampada non c'è una colonna di fusione a caldo o se la colonna di fusione a caldo non è calda, questo passaggio verrà regolato senza trattamento. Se la colonna di fusione a caldo è stata fusa per fissare il substrato di alluminio, tagliare la parte di fusione a caldo del punto di fusione a caldo con una pinza diagonale.



IN CASE OF ANY QUERY/ISSUE WITH THE PRODUCT, PLEASE REACH OUT TO US AT: SUPPORT@V-TAC.EU FOR MORE PRODUCTS RANGE, INQUIRY PLEASE CONTACT OUR DISTRIBUTOR OR NEAREST DEALERS. V-TAC EUROPE LTD. BULGARIA, PLOVDIV 4000, BUL.L.KARAVELOW 9B

INSTRUKCJA OBSŁUGI PODŚWIETLANY PANEL WPUSZCZANY LED



DANE TECHNICZNE

MODEL	SKU	KSZTAŁT	WATTS	LUMENY	KĄT WIĄZKI	IP RATING	CRI	TYP NADWOZIA	BIEŻĄCE OGÓLEM	MOC WEJŚCIOWA	ROZPIĘTOŚĆ ŻYCIA	CYKL WŁĄCZANIA/WYŁĄCZANIA	WYMIARY (dl. x szer. x wys.)
VT-61003	7855 10477	ROUND	3W	330LM	Sphere 360°	IP20	>80	PLASTIC	26mA	AC:220-240 50/60Hz	20000H	>15000	φ90.5x28mm
	7856 10478	SQUARE											90.2x90.2x28.2mm
VT-61006	7858 10480	ROUND	6W	660LM	Sphere 360°	IP20	>80	PLASTIC	36mA	AC:220-240 50/60Hz	20000H	>15000	φ120.5x28.4mm
	7859 10481	SQUARE											120.5x120.5x28.4mm
VT-61012	7861 10483	ROUND	12W	1200LM	Sphere 360°	IP20	>80	PLASTIC	71mA	AC:220-240 50/60Hz	20000H	>15000	φ170.8x28.4mm
	7862 10484	SQUARE											170.8x170.8x28.4mm
VT-61018	7864 10486	ROUND	18W	1850LM	Sphere 360°	IP20	>80	PLASTIC	103mA	AC:220-240 50/60Hz	20000H	>15000	φ220.8x28.9mm
	7865 10487	SQUARE		1980LM									220.4x220.4x28.8mm
VT-61024	7867 10489	ROUND	24W	2500LM	Sphere 360°	IP20	>80	PLASTIC	160mA	AC:220-240 50/60Hz	20000H	>15000	φ296x29.1mm
	7868 10490	SQUARE		2640LM									296x296x28.6mm

"Ten produkt zawiera źródło światła o klasie efektywności energetycznej <F/E>", gdzie <F/E> zastępuje się klasą efektywności energetycznej źródła światła.

WPROWADZENIE I GWARANCJA

Dziękujemy za wybranie i zakup produktu V-TAC. V-TAC będzie służył jak najlepiej. Przed rozpoczęciem instalacji należy uważnie przeczytać niniejszą instrukcję i zachować ją do wykorzystania w przyszłości. W przypadku jakichkolwiek innych pytań prosimy o kontakt z naszym dealerm lub lokalnym sprzedawcą, od którego zakupiono produkt. Są oni przeszkoleni i gotowi do świadczenia usług na najwyższym poziomie. Gwarancja jest ważna przez 2 lata od daty zakupu. Gwarancja nie obejmuje uszkodzeń spowodowanych nieprawidłową instalacją lub nadmiernym zużyciem. Firma nie udziela gwarancji na uszkodzenia powierzchni spowodowane nieprawidłowym demontażem i montażem produktu. Produkty są odpowiednio do pracy przez 10-12 godzin dziennie. Używanie produktu przez 24 godziny na dobę spowoduje utratę gwarancji. Ten produkt jest objęty gwarancją wyłącznie na wady produkcyjne.

OSTRZEŻENIE

- Przed rozpoczęciem instalacji należy wyłączyć zasilanie.
- Instalacja musi być wykonana przez certyfikowaną osobę.
- Źródło światła tej oprawy nie jest wymienne, gdy źródło światła osiągnie koniec żywotności, należy wymienić całą oprawę.
- Tylko do użytku wewnątrz pomieszczeń
- Jeśli zewnętrzny elastyczny kabel lub przewód tej oprawy oświetleniowej zostanie uszkodzony, powinien zostać wymieniony wyłącznie przez producenta lub jego przedstawiciela serwisowego lub podobną wykwalifikowaną osobę w celu uniknięcia zagrożenia.
- Metoda zamocowania kabla lub przewodu powinna być taka, aby wymiana mogła być wykonana wyłącznie przez producenta, jego przedstawiciela serwisowego lub podobną wykwalifikowaną osobę.



To oznaczenie wskazuje, że tego produktu nie należy wyrzucać razem z innymi odpadami domowymi.



Uwaga, ryzyko porażenia prądem.

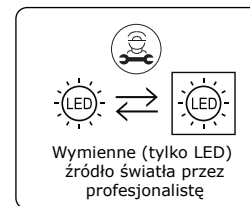

Wymienne (tylko LED) źródło światła przez profesjonalistę



FR Cet appareil, ses accessoires et cordons se recyclent



Points de collecte sur www.quefairedemesdechets.fr
Privilégiez la réparation ou le don de votre appareil !

UWAGA!

Nie należy patrzeć bezpośrednio na wiązkę światła LED. Produkt może być zasilany wyłącznie napięciem znamionowym lub napięciem mieszczącym się w podanym zakresie. Zabrania się używania produktu z uszkodzoną osłoną ochronną. Produkt nie może być używany w niekorzystnych warunkach, np. kurz, woda, wilgoć, wibracje, wybuchowa atmosfera powietrza, opary lub opary chemiczne itp. W obszarze silnych zakłóceń elektromagnetycznych działanie produktu może zostać zakłócone.

WYTYCZNE UŻYTKOWANIA/KONSERWACJA

Wszelkie prace konserwacyjne należy wykonywać po odłączeniu zasilania i ostygnięciu produktu. Urządzenie należy czyścić wyłącznie miękkimi i suchymi ściereczkami. Nie używaj chemicznych detergentów. Nie przykrywać produktu. Zapewnić swobodny dostęp powietrza. Produkt może nagrzać się do wyższej temperatury.

MONTAŻ

Przed montażem należy przeczytać instrukcję. Montaż powinien zostać przeprowadzony przez wykwalifikowanego elektryka. Należy zachować ostrożność. Produkt posiada styk/terminal ochronny. Niepodłączenie przewodu ochronnego może prowadzić do porażenia prądem. Schemat montażu: patrz ilustracje. Przed pierwszym użyciem należy sprawdzić prawidłowe zamocowanie mechaniczne i podłączenie do zasilania elektrycznego.

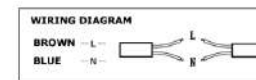

SCHEMAT INSTALACJI PANELU WPUSZCZANEGO

OKRĄGLY PANEL	3W	6W	12W	18W	24W
ROZMIAR OTWORU MONTAŻOWEGO	φ80 (77-82mm)	φ110 (107-112mm)	φ155 (150-155mm)	φ205 (200-205mm)	φ280 (275-280mm)

1. wycięć otwór za pomocą odpowiedniego narzędzia zgodnie z rozmiarem wycięcia.
2. wyłącz zasilanie i podłącz AC: napięcie 220-240 V z zaciskami.

3. Przytrzymaj dwa zaciski z powrotem przy lampce panelowej i wepchnij ją do otworu. Pozwól sprężynom podciągnąć lampę do sufitu.
4. Sprawdź, czy lampa jest płaska i naelektryzowana.
5. Wyczyść lampę czystą szmatką.
6. Włącz zasilanie i przetestuj światło.

PANEL KWADRATOWY	3W	6W	12W	18W	24W
ROZMIAR OTWORU MONTAŻOWEGO	80*80 (75-80mm)	110*110 (105-110mm)	155*155 (150-155mm)	205*205 (200-205mm)	280*280 (275-280mm)

1. wyciąć otwór za pomocą odpowiedniego narzędzia zgodnie z rozmiarem wycięcia.
2. wyłączyć zasilanie i podłączyć AC: napięcie 220-240 V z zaciskami.
3. Przytrzymaj dwa zaciski z powrotem przy lampce panelowej i wepchnij ją do otworu. Pozwól sprężynom podciągnąć lampę do sufitu.
4. Sprawdź, czy lampa jest płaska i naelektryzowana.
5. Wyczyść lampę czystą szmatką.
6. Włącz zasilanie i przetestuj światło.

4. nacisnąć klamrę na zewnątrz, zdjąć aluminiowy pasek dociskowy podłoża z bagnetu i zdjąć pasek dociskowy. Ten krok jest wymagany tylko w przypadku oświetlenia panelowego 24 W, inne elementy nie są wymagane.
5. Naciśnij klamrę na zewnątrz, usuń aluminiowe podłoże z klamry i wyjmij płytkę źródła światła.
6. wyjąć przewód dwużyłowy (średnica przewodu 18-22AWG) i włożyć go do zacisku wtykowego. Podłączyć zewnętrzne zasilanie w celu przetestowania.

SCHEMAT DEMONTAŻU

(Tylko dla zespołu nadzoru rynku)

1. wyłączyć zasilanie, dotknij środkowego obszaru płyty dyfuzyjnej spiczastym narzędziem i wyjmij pękniętą płytkę dyfuzyjną
2. odłączyć przewód zasilający od zacisku wtykowego
3. jeśli w korpusie lampy nie ma kolumny topliwej lub kolumna topliwa nie jest topliwa, ten krok zostanie dostosowany bez obróbki. jeśli kolumna topliwa została stopiona w celu zamocowania aluminiowego podłoża, odetnij topliwą część punktu topliwego za pomocą szczypiczek ukośnych.



IN CASE OF ANY QUERY/ISSUE WITH THE PRODUCT, PLEASE REACH OUT TO US AT: SUPPORT@V-TAC.EU FOR MORE PRODUCTS RANGE, INQUIRY PLEASE CONTACT OUR DISTRIBUTOR OR NEAREST DEALERS. V-TAC EUROPE LTD. BULGARIA, PLOVDIV 4000, BUL.L.KARAVELOW 9B

MANUAL DE INSTRUÇÕES

PAINEL DE ENCASTRAR COM RETROILUMINAÇÃO LED



DADOS TÉCNICOS

MODELO	SKU	FORMA	WATTS	LUMENS	FEIXE ÂNGULO	IP CLASSIFICAÇÃO	CRI	CORPO TIPO	TOTAL ACTUAL	ENTRADA ALIMENTAÇÃO	VIDA ESPAÇO	ON/OFF CICLO	DIMENSÃO (CxLxA)
VT-61003	7855 10477 7856 10478 7857 10479	ROUND	3W	330LM	Sphere 360°	IP20	>80	PLASTIC	26mA	AC:220-240 50/60Hz	20000H	>15000	φ90.5x28mm
		SQUARE											90.2x90.2x28.2mm
VT-61006	7858 10480 7859 10481 7860 10482	ROUND	6W	660LM	Sphere 360°	IP20	>80	PLASTIC	36mA	AC:220-240 50/60Hz	20000H	>15000	φ120.5x28.4mm
		SQUARE											120.5x120.5x28.4mm
VT-61012	7861 10483 7862 10484 7863 10485	ROUND	12W	1200LM	Sphere 360°	IP20	>80	PLASTIC	71mA	AC:220-240 50/60Hz	20000H	>15000	φ170.8x28.4mm
		SQUARE											170.8x170.8x28.4mm
VT-61018	7864 10486 7865 10487 7866 10488	ROUND	18W	1850LM	Sphere 360°	IP20	>80	PLASTIC	103mA	AC:220-240 50/60Hz	20000H	>15000	φ220.8x28.9mm
		SQUARE		1980LM									220.4x220.4x28.8mm
VT-61024	7867 10489 7868 10490 7869 10491	ROUND	24W	2500LM	Sphere 360°	IP20	>80	PLASTIC	160mA	AC:220-240 50/60Hz	20000H	>15000	φ296x29.1mm
		SQUARE		2640LM									296x296x28.6mm

"Este produto contém uma fonte luminosa da classe de eficiência energética <F/E>", em que <F/E> deve ser substituído pela classe de eficiência energética da fonte luminosa contida.

INTRODUÇÃO E GARANTIA

Obrigado por selecionar e comprar o produto V-TAC. A V-TAC irá servi-lo da melhor forma. Por favor, leia atentamente estas instruções antes de iniciar a instalação e mantenha este manual à mão para referência futura. Se tiver qualquer outra dúvida, contacte o nosso revendedor ou o vendedor local a quem adquiriu o produto. Eles têm formação e estão prontos para o servir da melhor forma. A garantia é válida por 2 anos a partir da data de compra. A garantia não se aplica a danos causados por instalação incorreta ou desgaste anormal. A empresa não dá qualquer garantia contra danos em qualquer superfície devido à remoção e instalação incorretas do produto. Os produtos são adequados para um funcionamento diário de 10-12 horas. A utilização do produto durante 24 horas por dia anularia a garantia. Este produto tem garantia apenas para defeitos de fabrico.

AVISO

- Certifique-se de que desliga a alimentação eléctrica antes de iniciar a instalação.
- A instalação deve ser efectuada por uma pessoa certificada.
- A fonte de luz desta luminária não é substituível. Quando a fonte de luz atinge o fim da sua vida útil, toda a luminária deve ser substituída.
- Apenas para utilização em interiores
- Se o cabo ou o cordão flexível externo dessa luminária estiver danificado, deve ser exclusivamente substituído pelo fabricante ou pelo seu agente de assistência ou por uma pessoa qualificada semelhante, de modo a evitar um perigo.
- O método de fixação do cabo ou do cordão é tal que qualquer substituição só pode ser efectuada pelo fabricante, pelo seu agente de assistência ou por uma pessoa com qualificações semelhantes.



Esta marcação indica que este produto não deve ser eliminado juntamente com outros resíduos domésticos.



Cuidado, risco de choque elétrico.

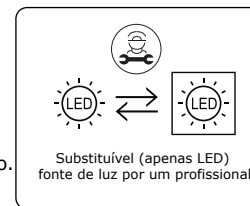

Substituível (apenas LED) fonte de luz por um profissional



FR Cet appareil, ses accessoires et cordons se recyclent

À DÉPOSER EN MAGASIN À DÉPOSER EN DÉCHÈTERIE OU



Points de collecte sur www.quefairemesdechets.fr
Privilégiez la réparation ou le don de votre appareil!

ATENÇÃO!

Não olhar diretamente para o feixe de luz LED. O produto só pode ser alimentado com a tensão nominal ou com a tensão dentro do intervalo previsto. É proibido utilizar o produto com a tampa de proteção danificada. O produto não deve ser utilizado em condições desfavoráveis, por exemplo, poeira, água, humidade, vibrações, atmosfera explosiva, fumos ou vapores químicos, etc. Em áreas com fortes interferências electromagnéticas, o funcionamento do produto pode ser afetado.

DIRETRIZES DE UTILIZAÇÃO/MANUTENÇÃO

Qualquer trabalho de manutenção deve ser efectuado quando a alimentação eléctrica estiver cortada e o produto tiver arrefecido. Limpar apenas com panos macios e secos. Não utilizar detergentes químicos. Não cobrir o produto. Assegurar um acesso livre ao ar. O produto pode aquecer a uma temperatura mais elevada.

MONTAGEM

Ler o manual antes de efetuar a montagem. A montagem deve ser efectuada por um electricista qualificado. Tenha cuidado. O produto tem um contacto/terminal de proteção. A não ligação do cabo de proteção pode provocar choques eléctricos. Esquema de montagem: ver imagens. Verificar se a fixação mecânica e a ligação à corrente eléctrica estão correctas antes da primeira utilização.

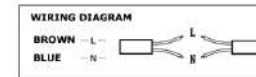

ESQUEMA DE INSTALAÇÃO DE PAINÉIS ENCASTRADOS

PAINEL REDONDO	3W	6W	12W	18W	24W
INSTALAÇÃO TAMANHO DO FURO	φ80 (77-82mm)	φ110 (107-112mm)	φ155 (150-155mm)	φ205 (200-205mm)	φ280 (275-280mm)

1. fazer um furo com uma ferramenta adequada de acordo com o tamanho do recorte.
2. desligar a alimentação e ligar AC: tensão de 220-240V com terminais.
3. Segure os dois cliques contra o painel luminoso e empurre-o para dentro do orifício. Deixe que as molas puxem a luz para cima, para o teto.
4. Verificar se a lâmpada está plana e electrificada.
5. Limpar a lâmpada com um pano limpo.
6. Ligar a alimentação eléctrica e testar a luz.

PAINEL QUADRADO	3W	6W	12W	18W	24W
INSTALAÇÃO TAMANHO DO FURO	80*80 (75-80mm)	110*110 105-110mm	155*155 150-155mm	205*205 200-205mm	280*280 275-280mm

1. fazer um furo com uma ferramenta adequada de acordo com o tamanho do recorte.

2. desligar a alimentação e ligar AC: tensão de 220-240V com terminais.

3. Segure os dois cliques contra o painel luminoso e empurre-o para dentro do orifício. Deixe que as molas puxem a luz para cima, para o teto.

4. Verificar se a lâmpada está plana e electricada.
5. Limpar a lâmpada com um pano limpo.
6. Ligar a alimentação eléctrica e testar a luz.

4. pressionar a fivela para fora, remover a tira de pressão do substrato de alumínio da baioneta e remover a tira de pressão. Este passo só é necessário para o painel luminoso de 24 W, os outros itens não são necessários.

5) Pressione a fivela para fora, retire o substrato de alumínio da fivela e retire a placa da fonte de luz.

6. retirar o cabo de dois fios (diâmetro do fio 18-22AWG) e inseri-lo no terminal de encaixe. Ligar a fonte de alimentação externa para efetuar o teste.

DIAGRAMA DE DESMONTAGEM

(Apenas para a equipa de fiscalização do mercado)

1. desligar a alimentação, bater na área central da placa de difusão com uma ferramenta pontiaguda e retirar a placa de difusão fissurada

2. remover o fio de alimentação do terminal da ficha

3. se não houver coluna de fusão a quente no corpo da lâmpada ou se a coluna de fusão a quente não for de fusão a quente, este passo será ajustado sem tratamento. se a coluna de fusão a quente tiver sido fundida para fixar o substrato de alumínio, cortar a parte de fusão a quente do ponto de fusão a quente com um alicate diagonal.



IN CASE OF ANY QUERY/ISSUE WITH THE PRODUCT, PLEASE REACH OUT TO US AT: SUPPORT@V-TAC.EU FOR MORE PRODUCTS RANGE, INQUIRY PLEASE CONTACT OUR DISTRIBUTOR OR NEAREST DEALERS. V-TAC EUROPE LTD. BULGARIA, PLOVDIV 4000, BUL.L.KARAVELOW 9B

MANUAL DE INSTRUCȚIUNI

A CONDUS PANOU CU ILUMINARE DIN SPATE ÎNCASTRAT



DATE TEHNICE

MODEL	SKU	SHAPE	WATTS	LUMENS	UNGHIIUL FASCICULULUI	IP RATING	CRI	TIPUL CORPULUI	TOTAL CURENT	PUTEREA DE INTRARE	DURATA DE VIAȚĂ	CICLU PORNIT /OPRIT	DIMENSIUNE (LxLxA)
VT-61003	7855 10477	ROUND	3W	330LM	Sphere 360°	IP20	>80	PLASTIC	26mA	AC:220-240 50/60Hz	20000H	>15000	φ90.5x28mm
	7856 10478	SQUARE											90.2x90.2x28.2mm
VT-61006	7858 10480	ROUND	6W	660LM	Sphere 360°	IP20	>80	PLASTIC	36mA	AC:220-240 50/60Hz	20000H	>15000	φ120.5x28.4mm
	7859 10481	SQUARE											120.5x120.5x28.4mm
VT-61012	7861 10483	ROUND	12W	1200LM	Sphere 360°	IP20	>80	PLASTIC	71mA	AC:220-240 50/60Hz	20000H	>15000	φ170.8x28.4mm
	7862 10484	SQUARE											170.8x170.8x28.4mm
VT-61018	7864 10486	ROUND	18W	1850LM	Sphere 360°	IP20	>80	PLASTIC	103mA	AC:220-240 50/60Hz	20000H	>15000	φ220.8x28.9mm
	7865 10487	SQUARE		1980LM									220.4x220.4x28.8mm
VT-61024	7867 10489	ROUND	24W	2500LM	Sphere 360°	IP20	>80	PLASTIC	160mA	AC:220-240 50/60Hz	20000H	>15000	φ296x29.1mm
	7868 10490	SQUARE		2640LM									296x296x28.6mm

"Acest produs conține o sursă de lumină din clasa de eficiență energetică <F/E>", unde <F/E> se înlocuiește cu clasa de eficiență energetică a sursei de lumină conținute.

INTRODUCERE ȘI GARANȚIE

Vă mulțumim că ați ales și ați cumpărat produsul V-TAC. V-TAC vă va servi cel mai bine. Vă rugăm să citiți cu atenție aceste instrucțiuni înainte de a începe instalarea și să păstrați acest manual la îndemână pentru referințe viitoare. Dacă aveți orice altă întrebare, vă rugăm să contactați dealerul nostru sau vânzătorul local de la care ați achiziționat produsul. Aceștia sunt instruiți și pregătiți să vă servească în cel mai bun mod. Garanția este valabilă timp de 2 ani de la data achiziției. Garanția nu se aplică în cazul deteriorărilor cauzate de instalarea incorectă sau de uzura anormală. Compania nu oferă nicio garanție împotriva deteriorării oricărei suprafețe din cauza îndepărtării și instalării incorecte a produsului. Produsele sunt potrivite pentru o funcționare zilnică de 10-12 ore. Utilizarea produsului timp de 24 de ore pe zi ar anula garanția. Acest produs este garantat numai pentru defecte de fabricație.

AVERTISMENT

- Vă rugăm să vă asigurați că opriți alimentarea cu energie electrică înainte de a începe instalarea.
- Instalarea trebuie să fie efectuată de o persoană certificată.
- Sursa de lumină a acestui corp de iluminat nu poate fi înlocuită, atunci când sursa de lumină ajunge la sfârșitul duratei de viață, întregul corp de iluminat trebuie înlocuit.
- Numai pentru utilizare în interior
- În cazul în care cablul sau cordonul flexibil extern al acestui corp de iluminat este deteriorat, acesta trebuie înlocuit exclusiv de către producător sau de către agentul de service al acestuia sau de către o persoană calificată similară, pentru a evita un pericol.
- Metoda de atașare a cablului sau a cablului este astfel încât orice înlocuire să poată fi efectuată numai de către producător, de către agentul său de service sau de către o persoană calificată similară.



Acest marcaj indică faptul că acest produs nu trebuie eliminat împreună cu alte deșeurile menajere.



Atenție, risc de electrocutare.

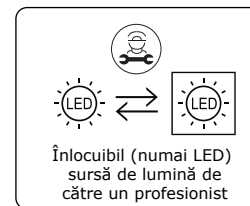

Înlocuibil (numai LED) sursă de lumină de către un profesionist



FR Cet appareil, ses accessoires et cordons se recyclent



Points de collecte sur www.quefairedemesdechets.fr
Privilégiez la réparation ou le don de votre appareil!

ATENȚIE!

Nu vă uitați direct la fasciculul de lumină LED. Produsul poate fi alimentat numai de tensiunea nominală sau de tensiunea din intervalul furnizat. Este interzisă utilizarea produsului cu capacul de protecție deteriorat. Produsul nu trebuie să fie utilizat în condiții nefavorabile, de exemplu, praf, apă, umiditate, vibrații, atmosferă cu aer exploziv, fum sau vapori chimici, etc. În zona de interferențe electromagnetice puternice, funcționarea produsului poate fi perturbată.

INSTRUCȚIUNI DE UTILIZARE/ÎNTREȚINERE

Orice lucrare de întreținere trebuie efectuată atunci când alimentarea cu energie electrică este întreruptă și produsul s-a răcit. Curățați numai cu cârpe moi și uscate. Nu utilizați detergenți chimici. Nu acoperiți produsul. Asigurați accesul liber la aer. Produsul se poate încălzi până la o temperatură mai mare.

MONTAJ

Citiți manualul înainte de montare. Montarea trebuie efectuată de un electrician calificat. Acordați atenție. Produsul are un contact/terminal de protecție. Neconectarea cablului de protecție poate duce la șocuri electrice. Diagrama de montare: consultați imaginile. Verificați fixarea mecanică adecvată și conectarea la curent electric înainte de prima utilizare.

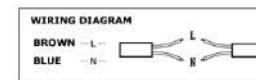

DIAGRAMĂ DE INSTALARE A PANOURII ÎNCASTRATE

1. Tăiați o gaură folosind o unealtă adecvată în funcție de dimensiunea decupajului.

2. Opriti alimentarea și conectați AC: 220-240V tensiune cu terminale.

PANOU ROTUND	3W	6W	12W	18W	24W
INSTALARE DIMENSIUNEA GAURII	φ80 (77-82mm)	φ110 (107-112mm)	φ155 (150-155mm)	φ205 (200-205mm)	φ280 (275-280mm)

3. Țineți cele două cleme înapoi de panoul luminos și împingeți-l în gaură. Permiteți arcurilor să tragă lumina până la tavan.

4. Verificați dacă lampa este plată și electricată.
5. Curățați lampa cu o cârpă curată.
6. Porniți alimentarea și testați lumina.

PANOU PĂTRAT	3W	6W	12W	18W	24W
INSTALARE DIMENSIUNEA GĂURII	80*80 (75-80mm)	110*110 105-110mm	155*155 150-155mm	205*205 200-205mm	280*280 275-280mm

1. Tăiați o gaură folosind un instrument adecvat în funcție de dimensiunea decupajului.

2. Opriti alimentarea și conectați AC: 220-240V tensiune cu terminale.

3. Țineți cele două cleme înapoi de panoul luminos și împingeți-l în gaură. Permiteți arcurilor să tragă lumina până la tavan.

4. Verificați dacă lampa este plată și electrificată. ON

5. Curățați lampa cu o cârpă curată.

6. Porniți alimentarea și testați lumina.

4. Apăsăți catarama spre exterior, îndepărtați banda de presare a substratului de aluminiu de pe baionetă și scoateți banda de presare. Acest pas este necesar doar pentru panoul de lumină de 24W, alte elemente nu sunt necesare.

5. Apăsăți substratul de aluminiu de pe cataramă și scoateți placa sursei de lumină.

6. Scoateți cablul cu două fire (diametrul firului 18-22AWG) și introduceți-l în terminalul de conectare. 7. Conectați sursa de alimentare externă pentru testare.

DIAGRAMA DE DEZASAMBLARE

(Numai pentru echipa de supraveghere a pieței)

1. opriti alimentarea, atingeți zona centrală a plăcii de difuzie cu un instrument ascuțit și scoateți placa de difuzie crăpată

2. Scoateți firul de alimentare de la terminalul de conectare

3. Dacă nu există o coloană de topire la cald în corpul lămpii sau dacă coloana de topire la cald nu este topită la cald, această etapă va fi ajustată fără tratament. 4. În cazul în care coloana de topire la cald a fost topită pentru a fixa substratul de aluminiu, tăiați partea de topire la cald a punctului de topire la cald cu un clește diagonal.



IN CASE OF ANY QUERY/ISSUE WITH THE PRODUCT, PLEASE REACH OUT TO US AT: SUPPORT@V-TAC.EU FOR MORE PRODUCTS RANGE, INQUIRY PLEASE CONTACT OUR DISTRIBUTOR OR NEAREST DEALERS. V-TAC EUROPE LTD. BULGARIA, PLOVDIV 4000, BUL.L.KARAVELOW 9B

MANUAL DE INSTRUCCIONES

PANEL EMPOTRABLE RETROILUMINADO CON LEDS



TECHNICAL DATA

MODELO	SKU	SHAPE	WATTS	LUMENS	HAZ ANGLUO	IP VALOR	CRI	CUERPO TIPO	TOTAL ACTUAL	ENTRADA ALIMENTACIÓN	VIDA SPAN	ENCENDIDO /APAGADO CICLO	DIMENSIONES (LxAxH)
VT-61003	7855 10477	ROUND	3W	330LM	Sphere 360°	IP20	>80	PLASTIC	26mA	AC:220-240 50/60Hz	20000H	>15000	φ90.5x28mm
	7856 10478	SQUARE											90.2x90.2x28.2mm
VT-61006	7858 10480	ROUND	6W	660LM	Sphere 360°	IP20	>80	PLASTIC	36mA	AC:220-240 50/60Hz	20000H	>15000	φ120.5x28.4mm
	7859 10481	SQUARE											120.5x120.5x28.4mm
VT-61012	7861 10483	ROUND	12W	1200LM	Sphere 360°	IP20	>80	PLASTIC	71mA	AC:220-240 50/60Hz	20000H	>15000	φ170.8x28.4mm
	7862 10484	SQUARE											170.8x170.8x28.4mm
VT-61018	7864 10486	ROUND	18W	1850LM	Sphere 360°	IP20	>80	PLASTIC	103mA	AC:220-240 50/60Hz	20000H	>15000	φ220.8x28.9mm
	7865 10487	SQUARE		1980LM									220.4x220.4x28.8mm
VT-61024	7867 10489	ROUND	24W	2500LM	Sphere 360°	IP20	>80	PLASTIC	160mA	AC:220-240 50/60Hz	20000H	>15000	φ296x29.1mm
	7868 10490	SQUARE		2640LM									295x295x28.6mm

Este producto contiene una fuente luminosa de clase de eficiencia energética <F/E>, donde <F/E> se sustituirá por la clase de eficiencia energética de la fuente luminosa contenida.

INTRODUCCIÓN Y GARANTÍA

Gracias por seleccionar y comprar un producto V-TAC. V-TAC le servirá lo mejor posible. Lea atentamente estas instrucciones antes de iniciar la instalación y conserve este manual a mano para futuras consultas. Si tiene cualquier otra duda, póngase en contacto con nuestro distribuidor o vendedor local al que haya comprado el producto. Están formados y preparados para atenderle lo mejor posible. La garantía es válida durante 2 años a partir de la fecha de compra. La garantía no se aplica a los daños causados por una instalación incorrecta o un desgaste anormal. La empresa no ofrece ninguna garantía contra daños en cualquier superficie debidos a una incorrecta retirada e instalación del producto. Los productos son adecuados para un funcionamiento de 10-12 Horas diarias. El uso del producto durante 24 horas al día anularía la garantía. Este producto está garantizado únicamente por defectos de fabricación.

ADVERTENCIA

- Asegúrese de desconectar la alimentación antes de iniciar la instalación.
- La instalación debe ser realizada por una persona certificada.
- La fuente de luz de esta luminaria no es sustituible, cuando la fuente de luz llegue al final de su vida útil deberá sustituirse toda la luminaria.
- Sólo para uso interior
- Si el cable o cordón flexible externo de esta luminaria está dañado, deberá ser sustituido exclusivamente por el fabricante o su agente de servicio o una persona cualificada similar para evitar riesgos.
- El método de fijación del cable o cordón debe ser tal que cualquier sustitución sólo pueda ser realizada por el fabricante, su agente de servicio o una persona cualificada similar.



Esta marca indica que este producto no debe eliminarse con otros residuos domésticos.



Precaución, riesgo de descarga eléctrica.

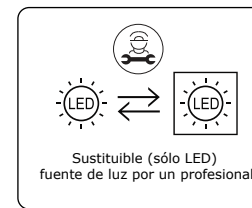

Sustituible (sólo LED) fuente de luz por un profesional



FR Cet appareil, ses accessoires et cordons se recyclent

À DÉPOSER EN MAGASIN À DÉPOSER EN DÉCHÈTERIE



Points de collecte sur www.quefairedemesdechets.fr
Privilégiez la réparation ou le don de votre appareil!

ATENCIÓN

No mire directamente al haz de luz LED. El producto sólo puede alimentarse con la tensión nominal o con la tensión dentro del rango previsto. Está prohibido utilizar el producto con la cubierta protectora dañada. El producto no debe utilizarse en condiciones desfavorables, por ejemplo, polvo, agua, humedad, vibraciones, atmósfera explosiva, humos o vapores químicos, etc. En zonas con fuertes interferencias electromagnéticas, el funcionamiento del producto puede verse afectado.

NORMAS DE USO/MANTENIMIENTO

Cualquier trabajo de mantenimiento debe realizarse cuando la alimentación eléctrica esté cortada y el producto se haya enfriado. Limpie sólo con paños suaves y secos. No utilice detergentes químicos. No cubra el producto. Asegúrese de que haya libre acceso de aire. El producto puede calentarse a una temperatura más elevada.

MONTAJE

Lea el manual antes del montaje. El montaje debe ser realizado por un electricista cualificado. Tenga cuidado. El producto tiene un contacto/terminal de protección. Si no se conecta el cable de protección, puede producirse una descarga eléctrica. Esquema de montaje: ver imágenes. Antes del primer uso, compruebe que la fijación mecánica y la conexión a la red eléctrica son correctas.



DIAGRAMA DE INSTALACIÓN DEL PANEL EMPOTRADO

PANEL REDONDO	3W	6W	12W	18W	24W
INSTALACIÓN	φ80	φ110	φ155	φ205	φ280
TAMAÑO DEL ORIFICIO	(77-82mm)	107-112mm	150-155mm	200-205mm	275-280mm

1. Corta un agujero utilizando una herramienta adecuada según el tamaño del recorte.
2. Desconecte la alimentación y conecte AC: 220-240V voltaje con terminals.
3. (Diagram showing the panel being inserted into the hole).
4. Compruebe si la lámpara está plana y electrificada.
5. Limpie la lámpara con un paño limpio.
6. Conecte la alimentación y pruebe la luz.

PANEL CUADRADO	3W	6W	12W	18W	24W
INSTALACIÓN	80*80	110*110	155*155	205*205	280*280
TAMAÑO DEL ORIFICIO	(75-80mm)	105-110mm	150-155mm	200-205mm	275-280mm

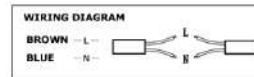
1. Corte un orificio con una herramienta adecuada de acuerdo con el tamaño del recorte.

2. Desconecte la alimentación y conecte AC: 220-240V voltaje con terminales.

3. Sujete los dos clips contra la luz del panel y empújela hacia el interior del orificio. Deje que los muelles tiren de la luz hacia el techo.

4. Compruebe si la lámpara está plana y electrificada.

5. Limpie la lámpara con un paño limpio.

6. Conecte la alimentación y pruebe la luz.

4. Presione la hebilla hacia fuera, retire la tira de prensado del sustrato de aluminio de la bayoneta y retire la tira de prensado. Este paso sólo es necesario para la luz del panel de 24W, otros elementos no son necesarios.

5. Presione la hebilla hacia fuera, retire el sustrato de aluminio de la hebilla y retire la placa de la fuente de luz.

6. Saque el cable de dos hilos (diámetro 18-22AWG) e insértelo en el terminal enchufable. Conecte la fuente de alimentación externa para la prueba.

DIAGRAMA DE DESMONTAJE

(Sólo para el equipo de vigilancia del mercado)

1. Apagar, golpear el área central de la placa de difusión con una herramienta puntiaguda y sacar la placa de difusión agrietada.

2. Retire el cable de alimentación del terminal de enchufe.

3. Si no hay columna de hot melt en el cuerpo de la lámpara o la columna de hot melt no está fundida, este paso se ajustará sin tratamiento. Si la columna de hot melt se ha fundido para fijar el sustrato de aluminio, corte la parte de hot melt del punto de hot melt con unos alicates diagonales.



IN CASE OF ANY QUERY/ISSUE WITH THE PRODUCT, PLEASE REACH OUT TO US AT: SUPPORT@V-TAC.EU FOR MORE PRODUCTS RANGE, INQUIRY PLEASE CONTACT OUR DISTRIBUTOR OR NEAREST DEALERS. V-TAC EUROPE LTD. BULGARIA, PLOVDIV 4000, BUL.L.KARAVELOW 9B