

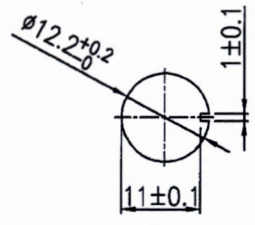

Rating	3A 125V AC/1.5A 250V AC 		
Contact Resistance	50m ohm Max		
Insulation Resistance	DC 500V 100M ohm Min		
Dielectric Strength	AC 1000V 1 minute		
Operation Tempure	-25°C~85°C		
Switch Function	2P SPST ON-OFF		



* Material:
 Frame: Black, PF
 Toggle: Zn Alloy, Ni Plated
 Terminals: Copper Alloy
 * No grease

1 HEX NUT IN BULK

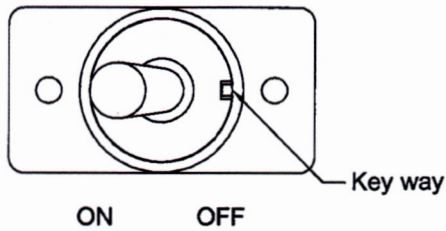
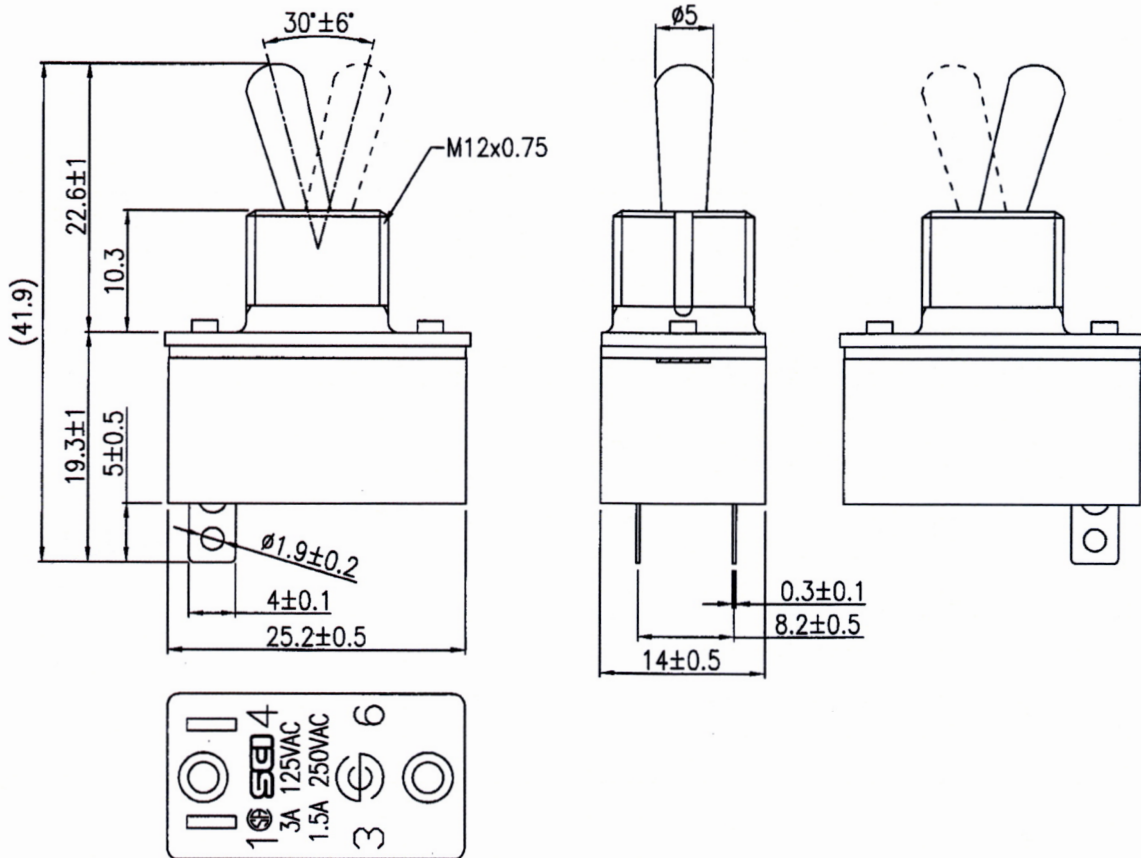

Tolerances Unless Otherwise Specified ±0.3

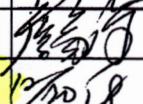
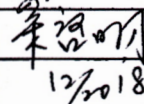
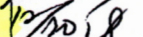
								△	
								△	
Date	Name	Description					No.		
Drawn	Checked	Approved	SCI BOM No.	Model Name		TOGGLE SWITCH			
林玥呈			Customer No.	Model No.		R13-2-05-(H)		Rev.	
12/20/18		12/20/18	Unit	mm	Shin Chin Industrial Co., Ltd.			X0	

Approved:



12/20/2018

WINZKI
 GmbH & Co. KG
 www.winzki.de