

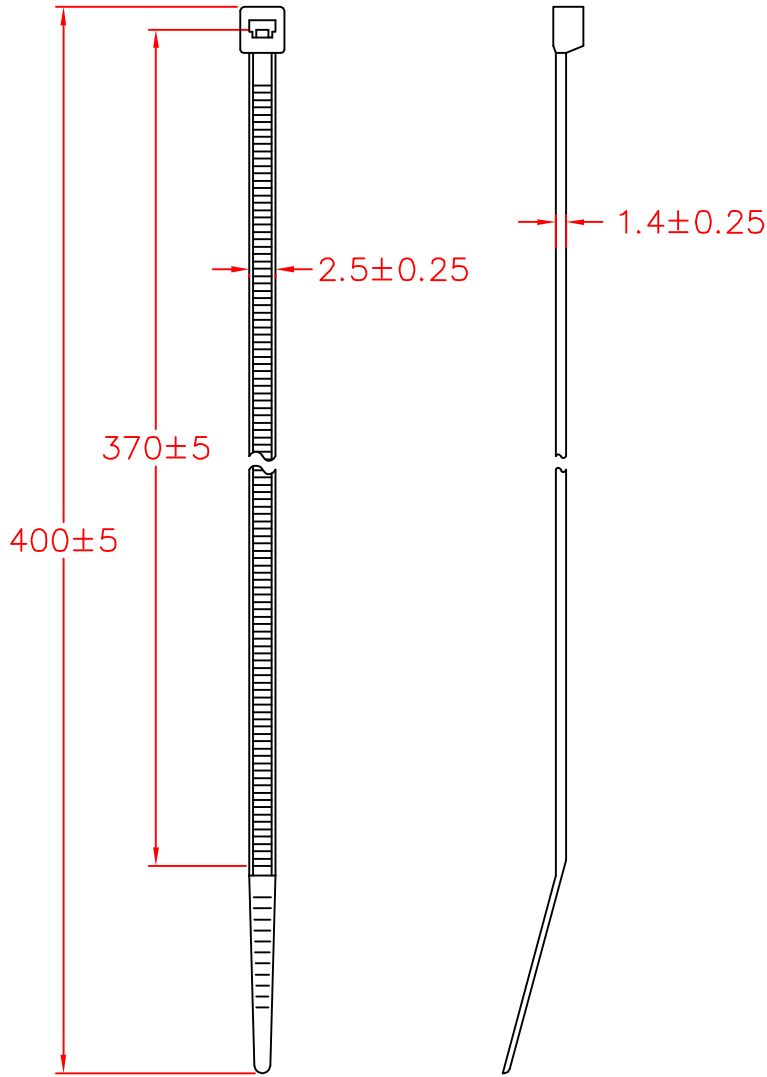

CV-400SW



承認
KSS
96.03.22
邱平裕

審查

製圖
KSS
96.03.22
謝文通

設計

中文名 抗UV紮線帶		MATERIAL UL 94V-2 NYLON 66	ITEM NO. CV-400SW
SCALE mm		FINISH	NAME UV Resistant Nylon Cable Tie
△ (' ')	TOLERANCE AS FIGURE		△ 03-22-2007 DATE REVISIONS K001
使用機種			R.NO.

