



ULTRA FRY

www.tefal.com

www.moulinex.com

www.arno.com.br

www.imusa.com.co

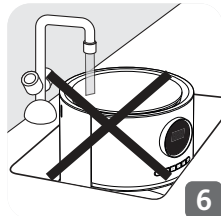
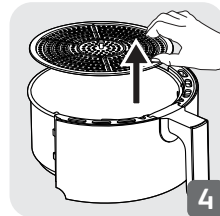
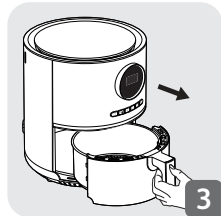
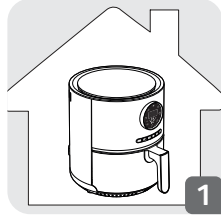
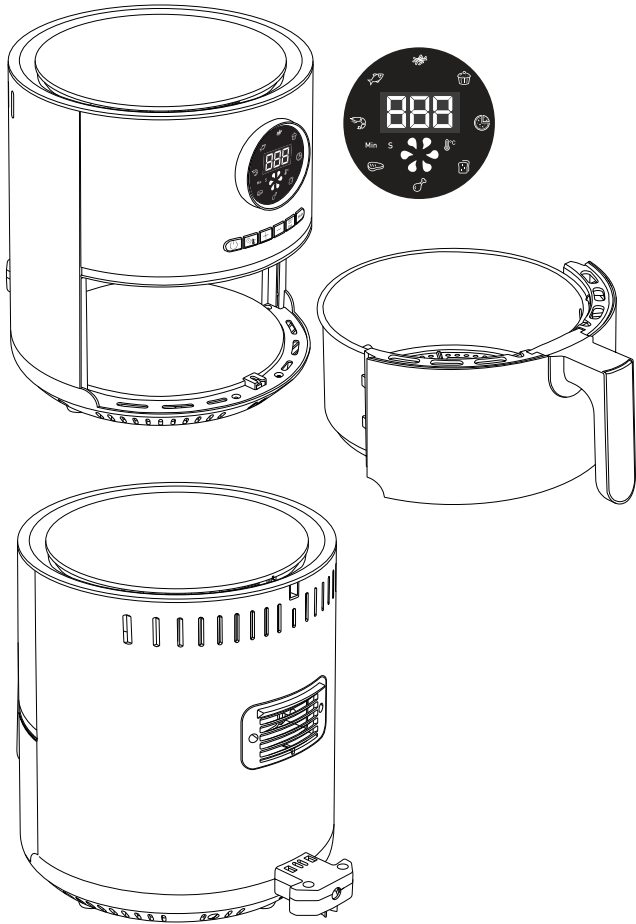



MAX 800 g

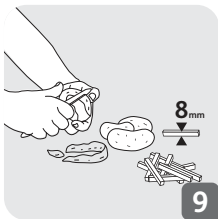

9



10



11

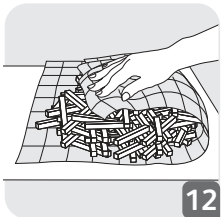

12



13



14

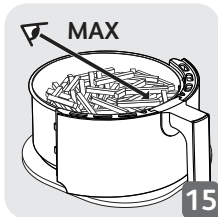

15



16



MAX 800 g



17



18

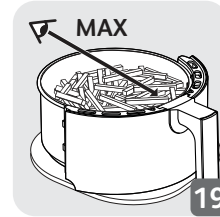







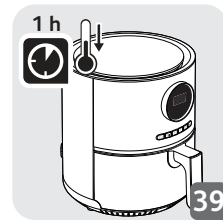
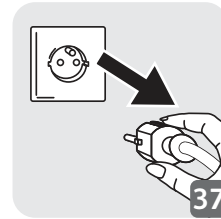
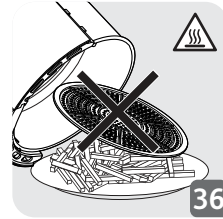
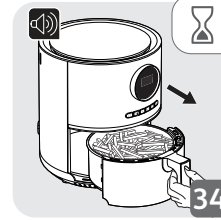
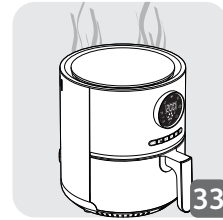
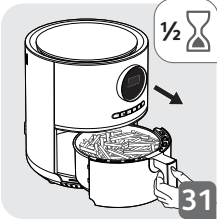
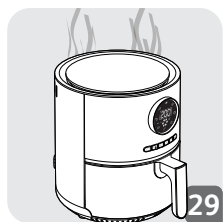
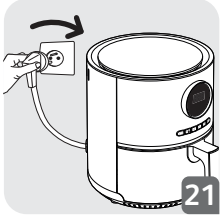

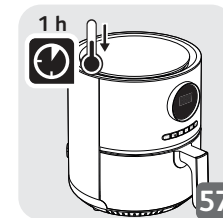
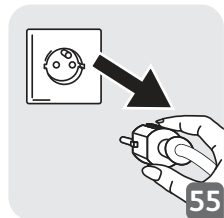
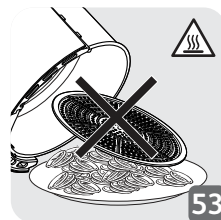
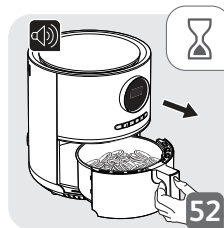
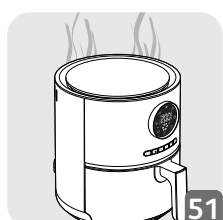
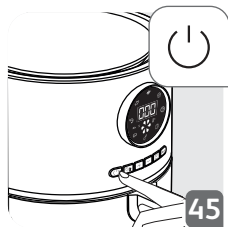
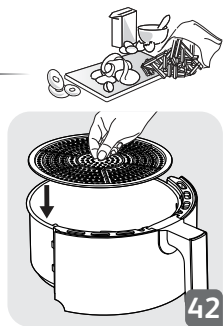
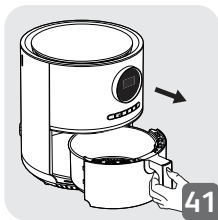
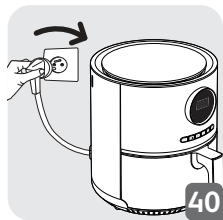





















19



20





						
	300 g - 800 g	15 - 25 min	200°C	✓		
	300 g - 800 g	22 - 27 min	200°C	✓		
	300 g - 800 g	22 - 32 min	200°C	✓		
	300 g - 700 g	16 - 20 min	200°C	✓		
	100 g - 500 g	12 - 20 min	180°C			
	1000 g	60 min	180°C			
	100 g - 600 g	7 - 15 min	180°C	✓		
	100 g - 500 g	8 - 12 min	180°C	✓		
	200g	8 - 10 min	200°C	✓		
	400 g	15 min	200°C			
	350 g	15 - 17 min	140°C			
	12 pieces	8 min	180°C			
	7 pieces	16 - 20 min	160°C			
	2 pieces	4 - 5 min	180°C			

6

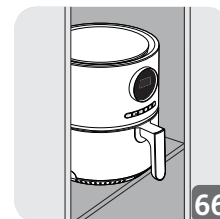
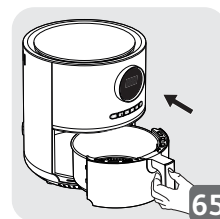
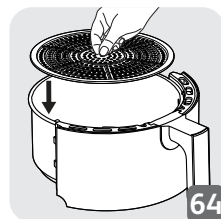
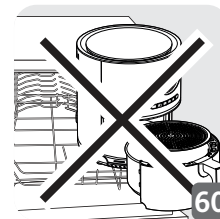
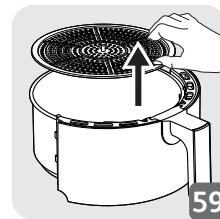
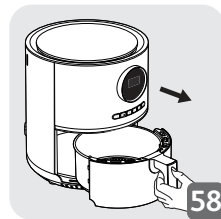

7



66