

Straight Pin Plug to Pin Socket

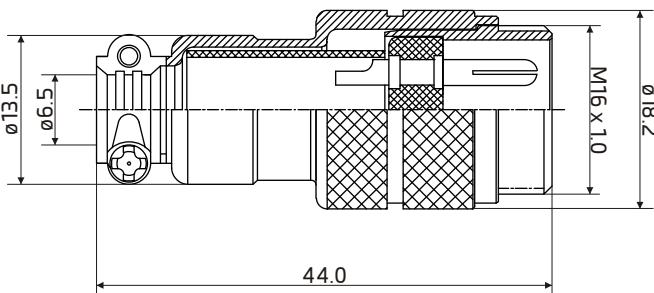
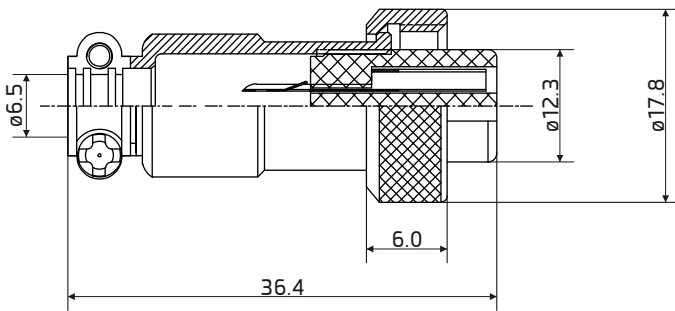

Dimension: mm±0.2

Specification

Number of Contacts: 4
Mating thread type: M16

Material

Shell: Nickel plated Zinc Alloy
Insulation: Black Bakelite
Contact: Silver plated Copper

Electrical

Operating voltage: 60V
Rated current: 7 A
Insulation resistance: 100 MΩ min.
Contact resistance: 10 mΩ max.

Environment

Operation temperature: -20 to 85°C
Protect class: IP55
Termination: Solder
Suit Cable size: O.D. ø6.5mm max.
Wire guide: AWG 16 - 14
Conductor cross-section: 1.3 - 2.1mm²