

**Straight Female Plug and
Panel Mount Male Socket**

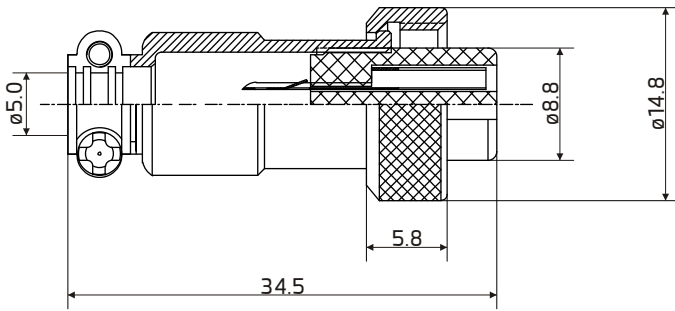

Specification

Number of Contacts: 6
Mating thread type: M12

Material

Shell: Nickel plated Zinc Alloy
Insulation: Black Bakelite
Contact: Silver plated Copper

Electrical

Operating voltage: 48V
Rated current: 1A
Insulation resistance: 100 MΩ min.
Contact resistance: 10 mΩ max.

Environment

Operation temperature: -20 to 85°C
Protect class: IP55
Termination: Solder
Suit Cable size: O.D. ø5mm max.
Wire guide: AWG 22 - 20
Conductor cross-section: 0.34 - 0.5mm²

