

### Straight Female Plug and Panel Mount Male Socket

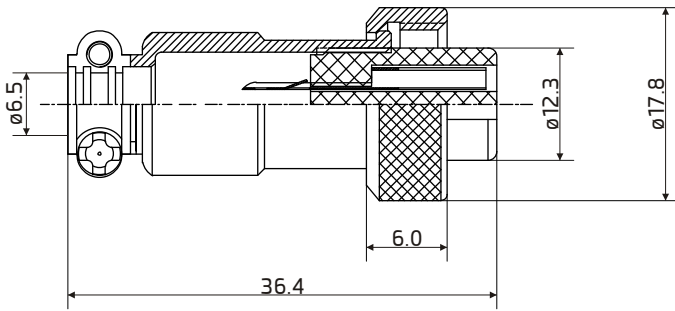

#### Specification

Number of Contacts: 9  
Mating thread type: M16

#### Material

Shell: Nickel plated Zinc Alloy  
Insulation: Black Bakelite  
Contact: Silver plated Copper

#### Electrical

Operating voltage: 30V  
Rated current: 1A  
Insulation resistance: 100 MΩ min.  
Contact resistance: 10 mΩ max.

#### Environment

Operation temperature: -20 to 85°C  
Protect class: IP55  
Termination: Solder  
Suit Cable size: O.D. ø6.5mm max.  
Wire guide: AWG 22 - 20  
Conductor cross-section: 0.34 - 0.5mm<sup>2</sup>

